



NAVITAR®

Imaging Components

Custom Optics

Projection Lenses

High Performance, High Quality Optical Solutions for Any Application

About Navitar, Inc.

Navitar, Inc. is a network of companies that design, manufacture, and distribute precision optical solutions. With manufacturing facilities in Rochester, New York and Wharton, New Jersey, Navitar creates lenses used in a myriad of industries, including Biotechnology and Medical, Defense and Security, Industrial Imaging, and Projection Optics. Applications range from machine vision to assembly, and imaging to photonics research and development.

Navitar's optical, mechanical, electrical, and manufacturing engineers truly understand all phases of optical design and manufacturing. Contact Navitar today to find out how we can apply our experience to your unique situation, regardless of industry or application.

Precision Optical Solutions for Any Application

Biotechnology and Medical

Navitar has been leading the advancement of medical imaging sciences from the development of the very first x-ray imaging optics for GE Healthcare over thirty years ago. Navitar's high-magnification optics are produced for a variety of medical and biotechnology processes including:

- Flow Cytometry
- Cellular Analysis
- Fluorescence Imaging
- DNA Sequencing
- *In vitro* Fertilization
- Two-Photon Microscopy



Defense and Security

Top defense contractors have been depending on Navitar since 1954 when the first Navitar-branded lens was developed for the United States Navy for use on CZR-1 missile tracking cameras. Navitar offers commercial-off-the-shelf (COTS) optical systems, as well as custom-built solutions for military, homeland security, and law enforcement applications including:

- SWIR Imaging
- Military Robotics
- Long-Range Surveillance
- 360° Situational Awareness
- Airborne Imaging
- Laser Weapons
- Laser Defense
- Training and Simulation Projection



Industrial Imaging

Navitar is the leading supplier of optics, optomechanical sub-assemblies, and optoelectronic system solutions for machine vision, automation assembly, imaging, and testing. Our optical designs are used in applications such as:

- Semiconductor Metrology
- Electronic Imaging
- Telecommunications
- Biometrics
- Photonics Research and Development
- Non-Contact Measurement
- Biotechnology

Projection Optics

Navitar designs and manufactures projection lenses that help to overcome the limitations of standard LCD and DLP projectors. Our off-the-shelf and custom solutions serve many different markets:

- Religious/Praise & Worship
- Home Theater
- Education
- Simulation
- Digital Display
- Planetarium
- Amusement/Theme Parks
- 2D/3D/4D Cinema
- Spherical Display Systems



Custom Lens Design

Optical Design, Manufacture, Testing & Precision Assembly

Navitar is one of the few lens companies that can seamlessly integrate unmatched engineering capabilities with rapid prototyping and volume custom lens production. We provide state-of-the-art optical and electro-optic solutions that meet the highest standards and solve challenging problems.

When your optical design project advances past the prototype stages, you can count on Navitar's manufacturing capabilities and customer service to deliver consistent quality.

Navitar's sophisticated solutions can be found in applications that demand the finest optical surfaces, highest accuracy and tightest tolerances. To learn how our expertise can bring your concepts to realization, contact your account manager at 585-359-4000 or email info@navitar.com

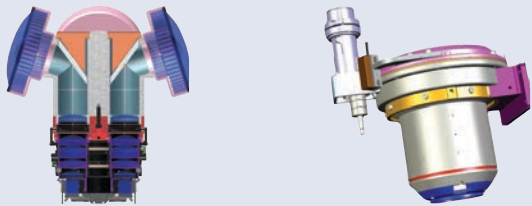

Custom Design Project Experience

- High NA Objectives
- Long-range Surveillance Lenses
- Femtosecond Laser Optics
- 360° Surveillance Lenses
- Laser Projection Optics
- Telecentric Inspection Lenses
- Projection Lenses
- Laser Beam Expanders
- Fisheye Lenses

Contents

Zoom 6000	4
12X Zoom	5
Precise Eye	6
Differential Interference Contrast (DIC) Modules	7
NIR Lens Systems	7
Motorized Solutions	8
Illumination Products	9
Custom Illumination.....	9
Fluorescent Imaging System	10
Fixed Tube Lens System	11
Dual View Lens System	11
Large Format Lenses	12
SWIR Hyperspectral Lenses.....	13
Navitar Machine Vision Lenses	14
Fujinon Video Lenses	14
High Speed Lenses	14
MagniStar® Bitelecentric Lenses	14
Zoom 7000 Series	15
Navitar Projection Optics	16
HemiStar® Fisheye Projection Lenses	17
NuView® Lenses	18
ScreenStar® Lenses	19
System Diagrams	20
Matrices and Specifications.....	33
Resources.....	41



Zoom 6000

A Workhorse to Fit Nearly Any Application

For high magnification applications, the Zoom 6000 series of lenses is the number one choice around the world. Recognized as the industry standard, our versatile 6.5X zoom lenses are designed to give you the magnification powers of traditional microscopes without the bulk or expense. They are easily integrated, assembled, and configured to your exact application. Compared with the competition, the Navitar Zoom 6000 series offers unmatched optical performance, repeatability and mechanical flexibility.

- Dynamic magnification range of 0.09-393X offers incredible versatility.
- High contrast images and vivid colors help your equipment perform better.
- 0.01-125.68 mm field coverage allows you to view a wide range of parts.
- Working distance can be varied from 13 to 390 mm.
- Add infinity corrected objective lenses to achieve unmatched edge flatness and clarity.
- Available with internal coaxial illumination. Review matrix on page 34 for FOV specifications. See the Zoom 6000 system diagram on pages 20-21.



Applications

Navitar high magnification lenses are utilized in a wide variety of biotechnology and nanotechnology applications including gel documentation, particle characterization, DNA sequencing, flow cytometry, AFM, colony picking, cell sorting and live cell imaging. Navitar high magnification systems are also utilized in the semiconductor and electronics industry for automated visual inspection, FPD fabrication, wafer inspection and non-contact measurement.

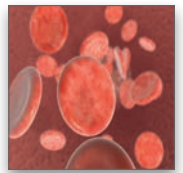
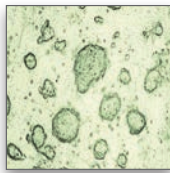
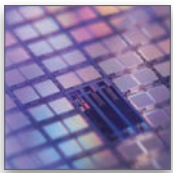

Zoom 6000 UltraZoom

Combine Infinity-Corrected Objectives for Maximum Resolution and Magnification

Navitar's UltraZoom is a high-performance zoom lens system ideal for semiconductor inspection, flow cytometry, and other high magnification applications. Its advanced design offers high resolution and outstanding contrast. This system incorporates infinity corrected, plan apochromatic objectives providing long working distances and excellent edge flatness and clarity.

Resolution varies from 420 to 1,650 lines per mm, depending on the microscope objective used. The UltraZoom is also available with fine focus and/or coaxial illumination.

Zoom 6000 Accessories

A full line of accessories is available for our Navitar high magnification imaging systems. To learn more visit www.navitar.com or contact your account manager.

- Right-Angle Mounts & Adapters
- Adapter Plates
- Laser Injection Port
- Auxiliary Viewing Port
- 2X F-Mount Adapter
- Polarizers
- Analyzer
- Infinity Corrected Objectives
- Aperture Control
- Detents
- Lens Attachments



12X Zoom

Navitar's Highest Combination of Zoom Range and Resolution in an Optical System

For high magnification applications requiring the optimal balance between optical performance, large zoom range and price, the 12X is an ideal choice. The 12X Zoom incorporates all the mechanical flexibility of the Zoom 6000 with extended zoom range, higher NA and unbeatable accuracy and repeatability for the most demanding applications. This outstanding combination of zoom range, coupled with large field coverage, means that you will now be able to view a wider range of parts with a single video inspection system and eliminate the need for bulky microscopes.

- Incredible 12X (0.58-7X) magnification for inspection of a wider range of parts.
- Increased resolution with 0.018-0.1 NA.
- Variable working distance from 13 to 341 mm.
- Field of view from 0.006 mm to 85.71 mm with attachments.
- Unmatched edge flatness and clarity.
- Works with 1/4", 1/3", 1/2" and 2/3" format cameras.
- The 12X Zoom System utilizes existing Zoom 6000 adapter tubes.
- Available with internal coaxial illumination. Review matrix on page 36 for FOV specifications. See the 12X Zoom system diagram on pages 22-23.



12X UltraZoom

Unmatched Optical Quality for High Magnification Applications

Navitar's 12X UltraZoom incorporates infinity corrected objectives in an advanced design that offers long working distances and outstanding edge flatness and clarity. The system's resolution exceeds 1,650 lines per mm, depending on the objective used. The UltraZoom is also available with fine focus or with fine focus and coaxial illumination.

12X Telecentric

Navitar offers a 12X Telecentric zoom system that allows users to reach a true telecentric condition to within 0.3 degrees, while maintaining constant perspective and magnification. Ideal for a wide range of applications, including precise dimensional measurement of objects or pattern recognition.

There are three telecentric adapters available for use with the 12X Zoom lens: straight (no coax), straight with coax, and right-angle folded with coax. Each has a working distance of anywhere between 166 mm and 188 mm. Magnifications range from 0.16X to 1.94X with the upper 1X adapter, and 0.32X to 3.88X with the 2X adapter. Maximum field of view is 50 mm. An upper 2X F-mount adapter may be used to couple a F-Mount camera. Please contact Navitar for detailed specifications.

Conventional Lens

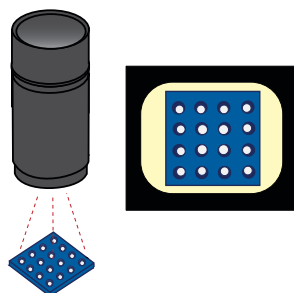

12X Telecentric Lens

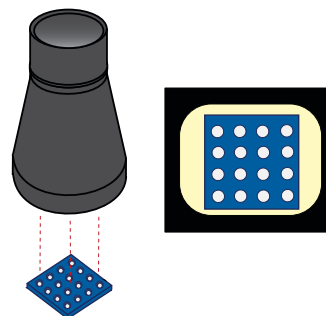

Precise Eye

Offering high magnification for fixed inspection applications, Navitar's Precise Eye series of lenses is designed to provide superior optical performance over standard C-mount video lenses. See the Precise Eye System diagram on pages 24-25.

- High resolution, diffraction-limited f/4.5 optical quality for high precision measurement and inspection.
- Long working distance makes lighting and handling easier.
- Coaxial lighting available for shadow-free illumination.
- Compatible with high-magnification infinity corrected objectives (5X, 10X, 20X, 50X).
- Mechanically stable for the most demanding vibration environments.
- Modular design for flexibility.
- Optics attach to any C-mount camera.
- Short tube length (~4 inches) and small diameter (1.25 inches).
- Allows for coaxial illumination and/or 3 mm fine focus.
- High transmission (>70%) over the visible to near IR spectrum.



Ultra Precise Eye

Navitar offers a variety of Ultra Precise Eye systems ideal for high magnification applications. The advanced design produces outstanding contrast and precision, while providing higher resolution and magnification than the standard Precise Eye. These systems incorporate infinity corrected objectives to provide long working distances and excellent edge flatness and clarity. The Ultra Precise Eye is also available with fine focus (1-61521) or with fine focus and coaxial illumination (1-61522).



Inspection of Atomic Force Microscope (AFM) probes using Navitar Ultra Precise Eye. Image courtesy of DeltaPix.

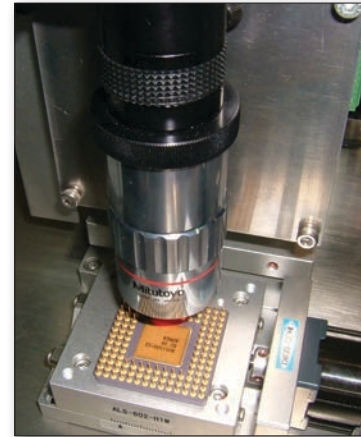

Navitar Ultra Precise Eye inspecting PCB components.

Ultra Precise Eye Magnification Matrix

	Mitutoyo 5X ICO (1-60226)	Mitutoyo 10X ICO (1-60227)	Mitutoyo 20X ICO (1-60228)	Mitutoyo 50X ICO (1-60229)
Working Distance	34 mm	33 mm	20 mm	13 mm
Numerical Aperture	0.14	0.28	0.42	0.55
Optical Magnification				
Precise Eye 0.5X Adapter Tube	2.27X	4.55X	9.1X	22.75X
Precise Eye 0.67X Adapter Tube	3.05X	6.1X	12.2X	30.5X
Precise Eye 1.0X Adapter Tube	4.55X	9.10X	18.2X	45.5X
Precise Eye 1.33X Adapter Tube	6.10X	12.2X	24.4X	61.0X
Precise Eye 2.0X Adapter Tube	9.10X	18.2X	36.4X	91.0X

Note: Any brand of infinity-corrected objective may be used.

Differential Interference Contrast Modules



Two Differential Interference Contrast (DIC) modules are available from Navitar:

- DIC Assembly Nikon High Resolution module (1-63726)
- DIC Assembly module (1-63102).

Both modules can be used on any ultra coax version (zoom or non-zoom) of the Zoom 6000 and 12X Zoom. The modules work with object side NAs ranging from 0.05 to 0.50, with optimal performance in the range from 0.15 to 0.4. Lens attachments operating in this range will serve for macro applications. Any infinity corrected objectives designed for incident light will suffice for micro.

DIC, when used with reflected light, can often be interpreted as a true three-dimensional representation of the surface geometry. It provides a clear distinction between raised and lowered regions in the specimen.

Visit www.navitar.com to learn more about our DIC modules. See the DIC Module system diagram on page 29.

Prism In

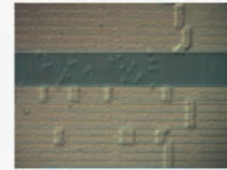

Prism Out



Prism In



Prism Out



3D topography of FOG (fill on glass) highlighted by employing differential interference contrast (DIC) and the Zoom 6000.

NIR Lens Systems

Navitar offers high magnification Zoom 6000, 12X Zoom and Precise Eye systems designed for use in the NIR. Each system has been specially coated to offer high resolution and unparalleled sensitivity for capturing microscopic images in the near infrared (NIR) wavelength band of 700-1550 nm. These modular lens systems can be configured to fit nearly any application.

Body tubes with detents and apertures or motorized are available by custom order. For a complete listing of available NIR parts, please visit www.navitar.com or contact your Navitar account manager.

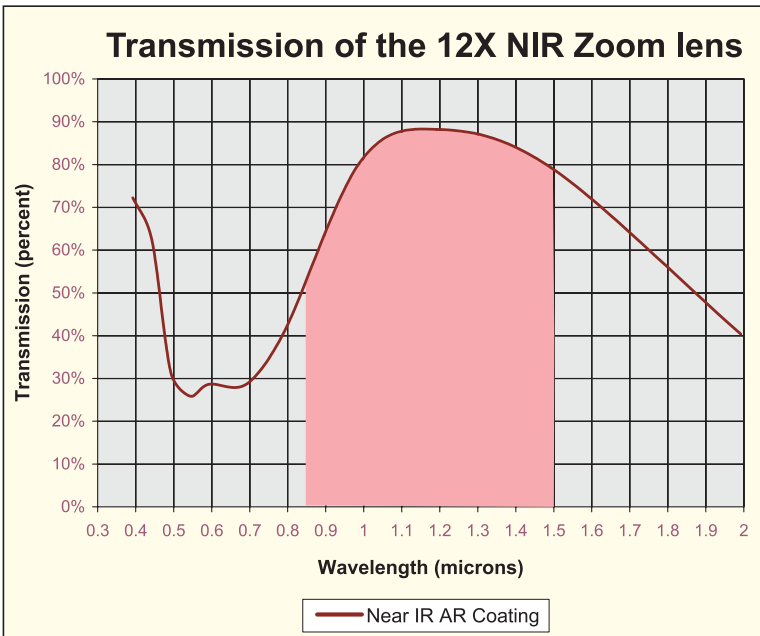

NIR Optical Applications

- Wafer Characterizations
- Laser Beam Profiling
- Optical Components Measurement & Analysis
- Fiber Alignment & Inspection
- Thermal Monitoring & Research
- Industrial Inspection
- Solar Cell Testing
- Food Inspection
- Pharmaceutical Applications

Motorized Solutions

More Robust Design

Navitar's motorization design, available on the 12X and Zoom 6000 systems, integrates magnetic Hall Effect sensors with reference position location. Hall Effect sensors are solid state devices with no moving parts.

Discovered by Edwin Hall in 1879, the Hall Effect is the production of a voltage difference across a conductor. A Hall Effect-sensing mechanism utilizes a magnetic field to trigger a pulse in a semiconductor circuit. Compared with photo-electric sensors, Hall Effect sensors are not affected by harsh, dirty or dusty environments, ambient room light, or variation in system voltages.

Users can choose to motorize both the zoom and focus axis, or just the zoom. Navitar offers three different motor types:

- 2-Phase Stepping Motor (Faulhaber)
- 5-Phase Stepping Motor (Oriental, Vexta)
- DC Servo with Encoder (Faulhaber)

Most motorized lenses are built to order, which may affect standard lead times.

Integrated Hall Effect Solid State Sensor Technology

- Unaffected by ambient light
- Unaffected by environmental contamination
- Unaffected by line voltage



Controller Options

HE Manual Motor Controller: Navitar's Hall Effect manual motor controller (1-62823) is designed to allow manual operation of any of the Navitar Hall Effect motorized lenses.

Motorized Control System: Motorized controllers feature single or dual axis control via serial RS-232 or USB. Control systems are available as table-top or board level for the OEM. Software includes LabVIEW VI and Windows Graphical User Interface (GUI) for simple axis control.

Contact Navitar for part numbers and further specifications.

Motorized Zoom 6000 Options

Fine Focus Type	Motor Type		
	2 ϕ Stepper	5 ϕ Stepper	Encoded/Servo
12 mm Motorized Fine Focus	1-62318	1-64426	1-62310
3 mm Motorized Fine Focus w/ Coax	1-62319	1-64428	1-62311
12 mm Manual Fine Focus	1-62523	1-64430	1-62522
3 mm Manual Fine Focus w/ Coax	1-62525	1-64432	1-62524
Non Fine Focus, Non Coax	1-62605	1-64434	1-62606
Non Fine Focus w/ Coax	1-62608	1-64436	1-62609

Motorized Zoom 6000 UltraZoom Options

Fine Focus Type	Motor Type		
	2 ϕ Stepper	5 ϕ Stepper	Encoded/Servo
12 mm Motorized Fine Focus	1-62316	1-64439	1-62308
3 mm Motorized Fine Focus w/ Coax	1-62317	1-64441	1-62309
12 mm Manual Fine Focus	1-62517	1-64443	1-62516
3 mm Manual Fine Focus w/ Coax	1-62639	1-64445	1-62633
Non Fine Focus, Non Coax	1-62637	1-64447	1-62631
Non Fine Focus w/ Coax	1-62638	1-64449	1-62632

Motorized 12X Zoom Options

Fine Focus Type	Motor Type		
	2 ϕ Stepper	5 ϕ Stepper	Encoded/Servo
12 mm Motorized Fine Focus	1-51188	1-52000	1-51190
3 mm Motorized Fine Focus w/ Coax	1-51200	1-52002	1-51202
12 mm Manual Fine Focus	1-51319	1-52004	1-51337
3 mm Manual Fine Focus w/ Coax	1-51311	1-52006	1-51338
Non Fine Focus, Non Coax	1-51314	1-52008	1-51335
Non Fine Focus w/ Coax	1-51318	1-52010	1-51336

Motorized 12X UltraZoom Options

Fine Focus Type	Motor Type		
	2 ϕ Stepper	5 ϕ Stepper	Encoded/Servo
12 mm Motorized Fine Focus	1-51192	1-52013	1-51194
3 mm Motorized Fine Focus w/ Coax	1-51196	1-52015	1-51198
12 mm Manual Fine Focus	1-51325	1-52017	1-51333
3 mm Manual Fine Focus w/ Coax	1-51326	1-52019	1-51334
Non Fine Focus, Non Coax	1-51320	1-52021	1-51331
Non Fine Focus w/ Coax	1-51324	1-52023	1-51332

Illumination Products

Lighting Accessories

Illumination has proven to be one of the most important components when designing a successful imaging system. Navitar understands that the correct lighting can only enhance the performance of our industry leading vision systems. We offer LED ring lights, Brightlight LED coaxial illuminators, fiber optic illuminators, and power supplies.

Fiber Optic Illumination

Fiber optic illuminators are the most versatile on the market today. Consisting of a high-powered light source, Navitar's fiber optic illuminators can be used with ring lights or flexible light pipes for oblique or coaxial illumination.

Navitar offers a series of high-intensity fiber optic illuminators and accessories that allow you to position your light for best possible viewing. These fiber optic illuminators consist of a halogen illumination system with a variable light intensity control. They accept a single or dual light pipe or an attachable ring light for illuminating a wider area.



LED Illumination

Navitar's LED-based ring lights and coaxial lights were designed with careful consideration for the standard working distances that most of our customers use. The components are low profile and provide bright, even illumination to complement the performance of your vision system.

Benefits Include:

- Longer life.
- Minimum power loss.
- Narrow wavelength band (red), constant color temperature (white).
- Small packaging with optimal heat management.
- No fan vibration.
- Lower cost.



Custom Illumination

Navitar designs and manufactures custom illumination systems specific to your application. Contact one of our application engineers to discuss your unique project requirements.

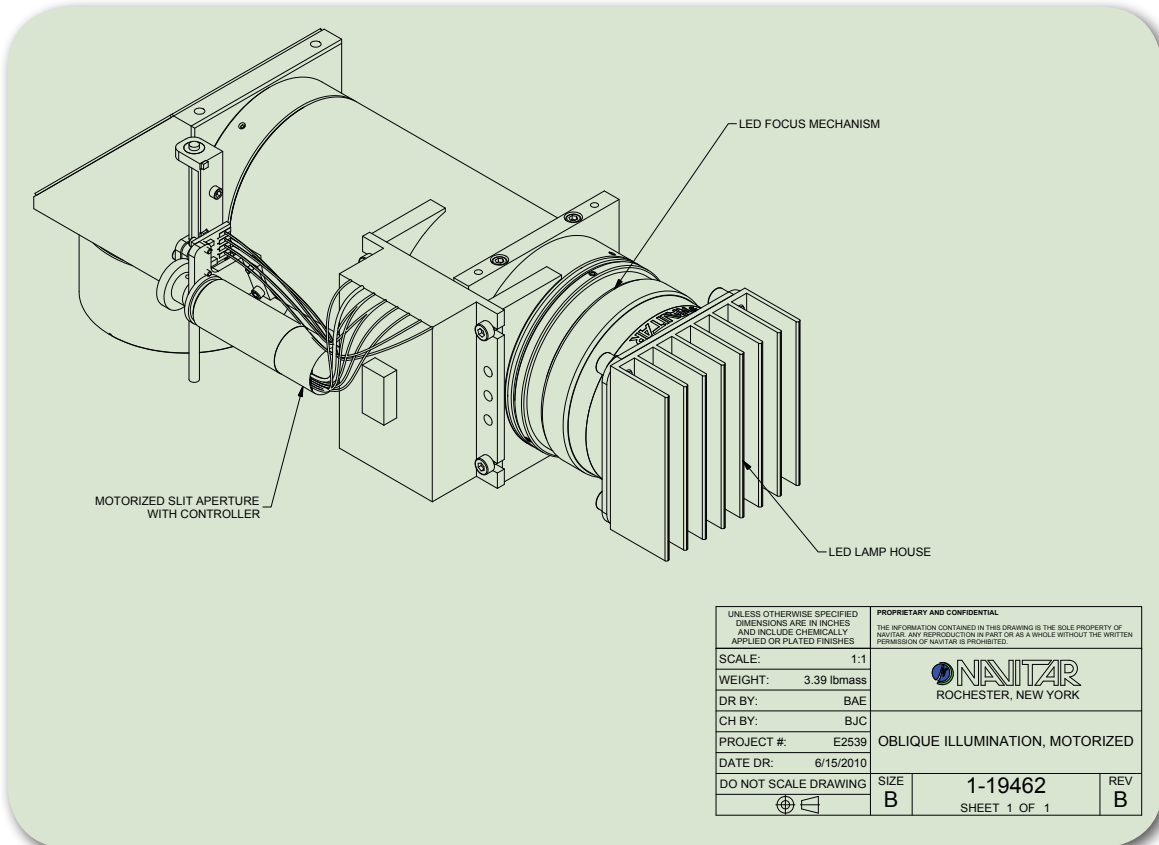

Fluorescent Imaging System

ZFL Fluorescent Video Scope

Navitar's Video ZFL Scope is a macro/micro fluorescence vision system that utilizes interchangeable fluorescence cubes and internal focus to create an image. The scope offers a simple, cost-effective solution for what are often sophisticated and complex fluorescence imaging tasks. A system diagram may be found on pages 26-27. A key feature of the ZFL system is its modularity. Our component parts can be configured into any type of system you can imagine.

Our macro fluorescence vision system encompasses a low-noise, scientific-grade digital camera, along with quantitative software, and LED illumination or UV light source. The micro imaging vision system mode provides a 0.9X coupling of any standard 200 mm tube length, infinity-corrected, fluorescent microscope objective to the camera. See our website for a complete list of Navitar's products for biomedical imaging applications.

Common Applications

- Flow Cytometry
- Live Cell Imaging
- Laser Confocal Imaging
- Cell Sorting
- DNA Sequencing
- Proteomics
- Microarray Scanning
- Gel Documentation
- Colony Picking
- Mass Spectrometry
- Air & Water Pollution Testing
- Forensic Examination
- Capillary Flow Observation
- Art Restoration

Features

- Utilizes interchangeable fluorescence cubes to create images compatible with most existing camera systems.
- Less expensive and more compact than a traditional microscope.
- Field of view up to 9.2 mm with a 2/3" CCD in macro mode.
- Micro mode utilizes infinity corrected objectives.
- Remote UV light source includes a long-life metal halide bulb.
- Zoom and fixed systems available. Fine focus is included with both systems.

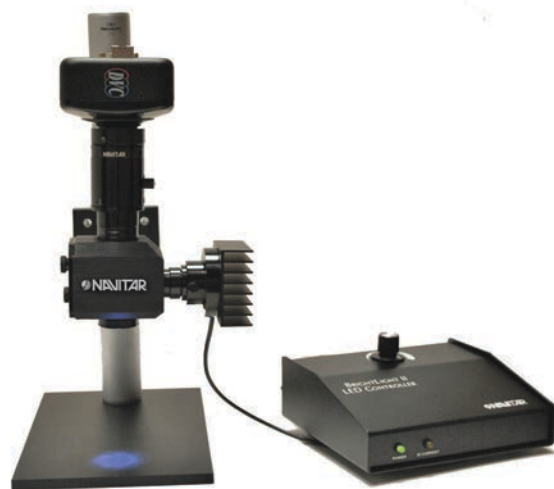

Macro ZFL Field of View Matrix

Lens Attachment	Working Distance	Camera Format	1X Mini or T-Mount	1.33X Mini	2X Mini, F-Mount or Standard
0.75x	108	Magnification	1.57x	2.11x	3.17x
		Sensor 1/4"	2.0 x 1.5	1.5 x 1.1	1.0 x 0.7
		Sensor 1/3"	3.0 x 2.3	2.3 x 1.7	1.5 x 1.1
		Sensor 1/2"	4.1 x 3.1	3.0 x 2.3	2.0 x 1.5
		Sensor 2/3"	5.6 x 4.2	4.2 x 3.1	none
None	86	Magnification	2.1x	2.82x	4.24x
		Sensor 1/4"	1.5 x 1.1	1.1 x 0.8	0.8 x 0.6
		Sensor 1/3"	2.3 x 1.7	1.7 x 1.3	1.1 x 0.8
		Sensor 1/2"	3.0 x 2.3	2.3 x 1.7	1.5 x 1.1
		Sensor 2/3"	4.2 x 3.1	3.1 x 2.3	none
1.5x	50	Magnification	3.13x	4.18x	6.27x
		Sensor 1/4"	1.0 x 0.8	0.8 x 0.6	0.5 x 0.4
		Sensor 1/3"	1.5 x 1.1	1.1 x 0.9	0.8 x 0.6
		Sensor 1/2"	2.0 x 1.5	1.5 x 1.1	1.0 x 0.8
		Sensor 2/3"	2.8 x 2.1	2.1 x 1.6	none
2.0x	37	Magnification	4.21x	5.64x	8.48x
		Sensor 1/4"	0.8 x 0.6	0.6 x 0.4	0.4 x 0.3
		Sensor 1/3"	1.1 x 0.9	0.9 x 0.6	0.6 x 0.4
		Sensor 1/2"	1.5 x 1.1	1.1 x 0.9	0.8 x 0.6
		Sensor 2/3"	2.1 x 1.6	1.6 x 1.2	none

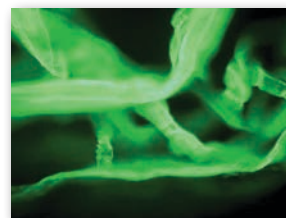
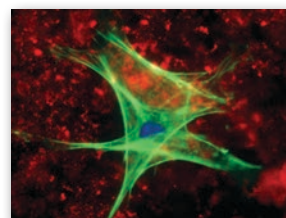
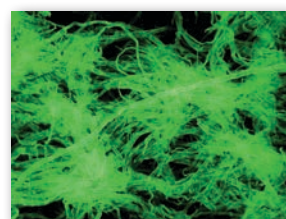

Fixed Tube Lens System

Navitar's fixed tube lens system was designed for customers utilizing larger sensors. With the correct combination of parts, this system can be used on 4/3" cameras (22 mm image circle). The components are designed to be highly corrected to eliminate chromatic aberrations. Our standard adapters and adapter modifiers may be placed above the tube lens.



1X Tube Lens Field of View Matrix

Objective Lens (Mitutoyo) Long W.D.	Working Distance (mm)	Camera Formats / Parameters	1.0X Adapter (HxV)	2.0X Standard Adapter (HxV)	2.0X Mini Adapter (HxV)	3.3X Adapter (HxV)
5X 0.14 NA DOF 0.026 mm	34	Mag.	5.0X	10.0X	10.0X	16.4X
		Field 2/3"	1.76 x 1.32	0.88 x 0.66	0.88 x 0.66	0.54 x 0.40
		Field 1"	2.56 x 1.92	1.28 x 0.96	1.28 x 0.96	0.78 x 0.59
		Field 4/3"	3.46 x 2.60	1.73 x 1.30	1.73 x 1.30	1.06 x 0.79
10X 0.28 NA DOF 0.006 mm	33.5	Mag.	10.0X	20.0X	20.0X	32.8X
		Field 2/3"	0.88 x 0.66	0.44 x 0.33	0.44 x 0.33	0.27 x 0.20
		Field 1"	1.28 x 0.96	0.64 x 0.48	0.64 x 0.48	0.39 x 0.29
		Field 4/3"	1.73 x 1.30	0.87 x 0.65	0.87 x 0.65	0.53 x 0.40
20X 0.42 NA DOF 0.003 mm	20	Mag.	20.0X	40.0X	40.0X	65.5X
		Field 2/3"	0.44 x 0.33	0.22 x 0.17	0.22 x 0.17	0.13 x 0.10
		Field 1"	0.64 x 0.48	0.32 x 0.24	0.32 x 0.24	0.20 x 0.15
		Field 4/3"	0.87 x 0.65	0.43 x 0.33	0.43 x 0.33	0.26 x 0.20
50X 0.55 NA DOF 0.002 mm	13	Mag.	50.0X	100.0X	100.0X	163.8X
		Field 2/3"	0.18 x 0.13	0.09 x 0.07	0.09 x 0.07	0.05 x 0.04
		Field 1"	0.26 x 0.19	0.13 x 0.10	0.13 x 0.10	0.08 x 0.06
		Field 4/3"	0.35 x 0.26	0.17 x 0.13	0.17 x 0.13	0.11 x 0.08

Dual View Lens System

Navitar's dual view system was initially developed for the thin film transistor (TFT) repair industry and has also been used for applications requiring a wide field of view range.

The dual view module offers the ultimate in adaptability and versatility; the system has a single objective lens and presents it to two separate imaging channels. These channels can be fixed, zoom, or a combination of the two. Two different light sources and wavelengths allow for the inspection of multiple types of materials. The use of different adapter tubes on each optical path provides a much wider field of view, without changing workstations or lighting setups.

The Dual View Lens System Diagram is found on page 30.

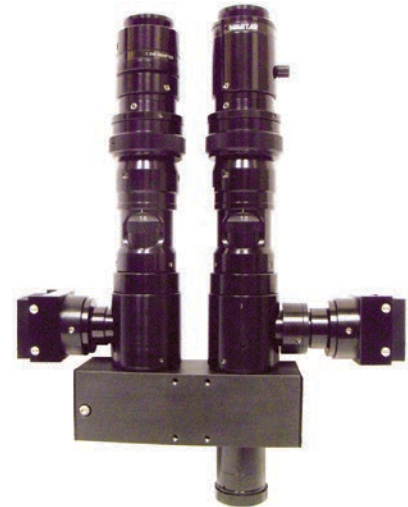

Large Format Lenses

Navitar's large format lenses meet the demands for high center to edge resolution, low distortion, and application specific F-numbers. These lenses are not modified video lenses; they are designed to match the performance abilities of high-end megapixel type cameras.

	Part #	Mount	Image Diagonal (mm)	Focal Length (mm)	F/# Range	Minimum Operating Distance (meters)	Image Size at MOD		Filter Thread		
							Width (mm)	Height (mm)			
Navitar	1-15838	F/C-mount	42	25	8 (fixed)	0.045	68	51	none		
	1-18820	Fmount/M42	43	50	2-22	0.5	340	250	M 58x0.75		
	1-17494	—	90	86	4-22	0.095	72	54	M 55x0.75		
	1-17709	—	65	107	3-22	0.15	70	52	M 72x0.75		
Zeiss	Standard	1-18808	Fmount	43	18	3.5-22	0.3	440	290	M 82x0.75	
		1-18809	Fmount	43	21	2.8-22	0.22	190	124	M 82x0.75	
		1-18810	F-mount	43	25	2.8-22	0.17	830	550	M 58x0.75	
		1-18811	F-mount	43	28	2-22	0.24	170	110	M 58x0.75	
		1-18812	F-mount	43	35	2-22	0.3	190	130	M 58x0.75	
		1-18813	F-mount	43	50	1.4-16	0.45	240	160	M 58x0.75	
		1-18814	F-mount	43	50	2-22	0.24	720	480	M 67x0.75	
		1-18815	F-mount	43	85	1.4-16	1	360	240	M 72x0.75	
		1-18816	F-mount	43	100	2-22	0.44	720	480	M 67x0.75	
	IR	1-18817	F-mount	43	25	2.8-22	0.17	85	56	M 58x0.75	
		1-18818	F-mount	43	50	1.4-16	0.45	240	160	M 58x0.75	
		1-18819	F-mount	43	85	1.4-16	1	360	240	M 72x0.75	
	Kowa	Standard	1-19711	Fmount	43.3	28	2.8-16	0.3	388	291	M 72x0.75
1-19712			F-mount	43.3	35	2.8-16	0.26	210	158	M 52x0.75	
1-19713			Fmount	43.3	50	2.8-16	0.26	135	102	M 52x0.75	
4/3"		IR	1-19908	Fmount	30	28	2.8-22	0.5	247	185	M 72x0.75
		1-19910	C-mount	23	12	2.0-22	0.1	182	136	M 55x0.75	
		1-19911	C-mount	23	16	2.0-22	0.1	135	101	M 40.5x0.5	
		1-19912	C-mount	23	25	2.0-16	0.15	125	93	M 40.5x0.5	
		1-19913	C-mount	23	35	2.0-16	0.2	100	75	M 37.5x0.5	
		1-19909	Fmount	43.3	50	1.9-16	0.5	269	202	M 52x0.75	
		1-19914	C-mount	23	50	2.0-22	0.3	100	75	M 37.5x0.5	



Large Format Lenses Offer Many Benefits

- Larger format design for line scan and area scan cameras.
- Low distortion center-to-edge.
- Wide field design for close-up imaging.
- Large depth of field.
- Diffraction limited.
- Exceptional contrast.

SWIR Hyperspectral Lenses

Navitar's fixed focal length SWIR Hyperspectral lenses are specifically designed for short wave infrared (SWIR) cameras and applications. SWIR Hyperspectral imaging applications require the optical system to efficiently transmit light in the visible, NIR and SWIR wavelengths. To do this, the lens design and coatings must be capable of maintaining a high level of transmission throughout a broad wavelength range.

Navitar's SWIR Hyperspectral lenses offer high resolution images in conditions ranging from bright daylight, fog/haze, twilight and dusk. Our standard SWIR lenses are specially coated for imaging in the SWIR wavelength, and designed to cover 1" (16 mm diagonal) sensors. They offer high resolution images and transmission in the 700 - 1900 nm wavelength of 75% or better.

Navitar's newest OptiStar® lenses are designed and optimized for high performance in SWIR applications. These lenses function in the wavelengths of 500 - 1700 nm with 90% +/- 5% transmission across the range, and are ideal for dark or nighttime applications.



Common Applications

- Night/Day Security
- Solar Panel
- Semiconductor Wafer Inspection
- Perimeter Surveillance
- Machine Vision
- Medical
- Biometrics
- Aerial Imaging
- Food Sorting

Standard SWIR Lenses - 1" Format for use with 1/2", 2/3" and 1" Cameras

Model	Focal Length (mm)	F-Stop Iris Range	Iris Control	Focus Control	Object Area (mm) at M.O.D. (HxV); 1"	Object Area (mm) at M.O.D. (HxV); 2/3"	Object Area (mm) at M.O.D. (HxV); 1/2"	Focusing Range (meters)	Mount Type
SWIR-8	8	1.4-16	Manual*	Manual*	167 x 123	112 x 82	80 x 59	0.1 - inf.	C
SWIR-12	12.5	1.4-16	Manual*	Manual*	316 x 233	213 x 158	165 x 123	0.3 - inf.	C
SWIR-16	16	1.4-16	Manual*	Manual*	244 x 181	165 x 123	119 x 89	0.3 - inf.	C
SWIR-25	25	1.4-16	Manual*	Manual*	161 x 120	109 x 82	79 x 59	0.3 - inf.	C
SWIR-35	35	1.4-16	Manual*	Manual*	110 x 182	75 x 56	54 x 41	0.3 - inf.	C
SWIR-50	50	1.4-16	Manual*	Manual*	122 x 91	84 x 63	61 x 46	0.5 - inf.	C

* Manual iris and focus with locking screws.

OptiStar® Lenses - 1/2" Format for use with 1/2" and 1/3" SWIR Cameras

Model	Focal Length (mm)	F-Stop Iris Range	Iris Control	Focus Control	Object Area (mm) at M.O.D. (HxV); 1/2" CCD	Object Area (mm) at M.O.D. (HxV); 1/3" CCD	Focusing Range (meters)	Mount Type
1-18882	25	1.4-11	Manual*	Manual*	194 x 135	146 x 101	1 - inf.	C
1-19179	50	1.1-8	Manual*	Manual*	102 x 78	77 x 59	1 - inf.	C

* Manual iris and focus with locking screws.

Custom SWIR Lens Design Experience

Navitar offers custom-designed SWIR solutions and welcomes your project request. We have designed and built several custom lenses, including a system that detects visible near infrared (NIR) and short wave infrared (SWIR) wavelengths (500 - 1600 nm). The custom design was a F/1.35, 25 mm, C-mount lens.

Please contact your account manager for a custom SWIR quote today.

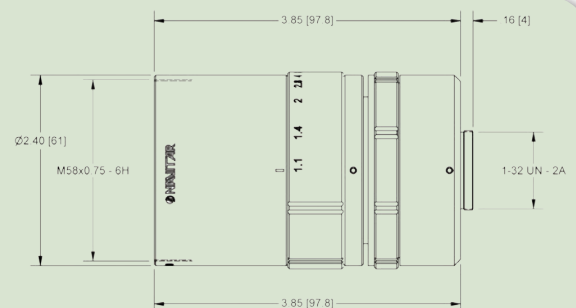

Navitar Machine Vision Lenses

Navitar's low magnification CCTV lens offerings are the benchmark against which all CCTV video lenses should be measured. Quality construction, coupled with precision engineering, results in high resolution, optically precise video lenses. We offer a complete range of imaging lenses for every industrial and robotic image processing application.

- Up to 3K sensor coverage
- High resolution
- Low distortion
- Megapixel lenses
- High speed lenses
- Affordable pricing



Fujinon Video Lenses

Navitar offers a wide range of Fujinon video lenses. Fujinon lenses are ideal for the growing number of video imaging applications in which a single, constant magnification factor and a fixed working distance are required to maximize contrast and performance.



High Speed Lenses

Navitar high speed fixed focal length lenses work with CCD & CMOS cameras. Our C-Mount, 1" format lenses are designed for 17, 25 and 50 mm focal lengths and are well suited for low light applications. Please call us for more information on motorized versions.



Telecentric Lenses

These high-resolution, low distortion lenses are designed to work with camera formats of 2/3" and smaller and also support megapixel cameras with 3.5µm pixels. Applications include metrology, flat panel inspection, curved surface inspection, and other imaging applications when greater depth of field is required.

MagniStar® Bi-Telecentric Lenses - C Mount

Part #	Magn.	Telecentricity (degree)	Distortion (%)	FOV 1/3" H x V (mm)	FOV 1/2" H x V (mm)	FOV 1/1.8" H x V (mm)	FOV 2/3" H x V (mm)	Working Distance (mm)	System F#	MTF@ 70 lp/mm (%)	Field Depth (mm)
I-23723	0.05X	0.03	0.02	94.1 x 70.6	125.5 x 94.1	140.7 x 104.3	172.5 x 129.4	531	F/8	>51	260
I-23522	0.128X	0.05	0.01	37.5 x 28.1	50.0 x 37.5	56.1 x 41.6	68.8 x 51.6	179	F/7	>55	31
I-23591	0.243X	0.04	0.02	19.8 x 14.8	26.3 x 19.8	29.5 x 21.9	36.2 x 27.2	104	F/8	>50	11
I-23524	0.528X	0.09	0.035	9.1 x 6.8	12.1 x 9.1	13.6 x 10.1	16.7 x 12.5	45	F/7	>51	2
I-24162	1.0X	0.02	0.02	4.8 x 3.6	6.4 x 4.8	7.2 x 5.3	8.8 x 6.6	63	F/11	>36	1.2
I-24056	2.0X	0.01	0.02	2.4 x 1.8	3.2 x 2.4	3.6 x 2.7	4.4 x 3.3	57	F/11	>31	0.3

MagniStar® Bi-Telecentric Lenses - F Mount

Part #	Magn.	Telecentricity (degree)	Distortion (%)	FOV 1" H x V (mm)	FOV 4/3" H x V (mm)	FOV 43.3mm H x V (mm)	Working Distance (mm)	System F#	MTF@ 70 lp/mm (%)	Field Depth (mm)	Mount Part #
I-24531	0.5X	0.047	0.02	25.6 x 19.2	36 x 27	72 x 48	172	F/16	>23	4	I-24541

Zoom 7000 Series

Navitar's Zoom 7000 series includes lenses used in a wide range of applications. The Zoom 7000 is ideal for quality assurance, biomedical imaging and industrial applications; the Navitar Zoom 7010 allows for high resolution imaging and is excellent for visual inspection of electronic components.



Zoom 7000

The Zoom 7000 is a versatile, close-focusing macro video lens specifically designed for applications where objects over 1" in diameter must be imaged. It offers unsurpassed clarity and parfocal zoom capabilities and is compatible with cameras 2/3" or smaller.

Features

- Working distance 5" to infinity.
- Parfocal over entire zoom range.
- Highest mag. 1.1X at 5" (at camera).
- 6X magnification power over 18 mm to 108 mm focal range.



Motorized Zoom 7000

Navitar also offers a Motorized Zoom 7000 with 2-phase stepper motors for zoom and aperture control. The Motorized Zoom 7000 is ideal for automated quality inspection and assembly, biomedical imaging, printed circuit board (PCB) and electronic inspection, and fuel gauge monitoring.

Features

- 2-phase stepper motors.
- Hall Effect sensors to reference position.
- Compatible with Navitar 2-phase controllers (2-62577, 1-62420).
- Windows-compatible.



Zoom 7010

The Navitar Zoom 7010 Macro Zoom lens is specifically designed for use with a 1/3" or smaller camera and has a 10X zoom ratio. The 10X Macro Zoom lens allows close-up image capture without extension tubes or close-up lenses and the up-to-10X magnification variable (zooming) capability allows small objects to be expanded for close-up observation.

Features

- Imaging at distances from 7-12"
- Working distance of 16" to infinity when the built-in close-up lens is removed.
- Very high resolution.
- C-mount is standard.



Zoom 7000E

The Zoom 7000E system is designed for use in educational applications where industrial inspection and imaging features are less essential. It offers a 6:1 zoom ratio over a focal range of 12.5 mm to 75 mm. The Zoom 7000E system incorporates many of the features of the Zoom 7000 and 7010 systems at an attractive price.

Features

- Eliminates eyestrain from prolonged microscope viewing.
- Can be used as overhead video projector.
- Provides high-resolution color images.
- Works under room light conditions.



Zoom Xtender

The Zoom Xtender allows you to adjust your lens working distance from 150 mm to infinity. The Xtender allows you to maintain your internal focus and parfocal zooming, as well as keep your computer controlled motorization and detents.

Features

- Maintains internal focus and parfocal zooming
- Adjusts working distance 150mm to infinity
- Online Zoom Xtender Calculator www.navitar.com/support/xtender_calculator.html

HemiStar® Fisheye Projection Lenses

Navitar has designed and produced world-class projection lenses since 1978. Today, we offer an innovative series of HemiStar lenses ideal for small, medium and large planetariums, as well as simulation and immersive projection.

Our fisheye projection lenses have an almost infinite depth of focus, allowing them to maintain sharpness in a variety of settings.

We offer both single- and multi-projector solutions for either 2K or 4K resolution.

Exciting Applications

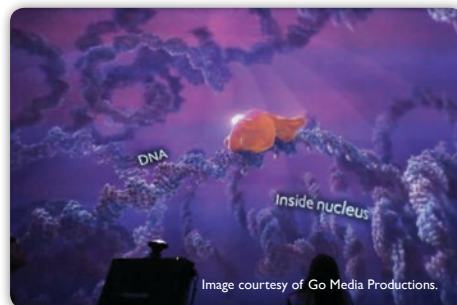
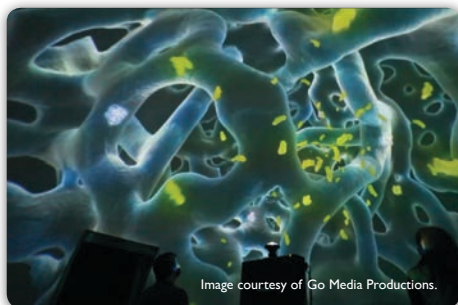
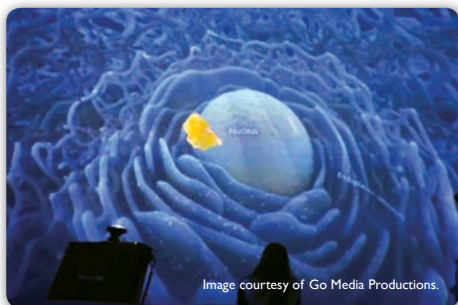

IMMERSIVE ENVIRONMENTS • COMMAND & CONTROL • AUTOMOTIVE DESIGN • EDUCATION
PLANETARIUMS • PRAISE & WORSHIP • SIMULATION • MUSEUMS • THEME PARKS & ATTRACTIONS

Markets We Serve

- 3D/4D Theater
- Cinema Advertising
- Consumer Electronics
- Corporate
- Digital & Retail Signage
- Education
- Government & Military
- Home Theater
- Interactive Projection & Amusement
- fMRI Projection Applications
- Planetarium
- Portable Presentation
- Rental & Staging
- Spherical Display Systems
- Training & Simulation
- Worship Facilities



Custom and 4K Projection Optics

Custom Projection Optics

Navitar offers custom projection lens solutions. Our design team of optical, mechanical and electrical engineers have years of experience and are ready to design and seamlessly integrate a custom projection lens into your system. Contact us today for a quote.

4K Projection Lenses

We offer lenses for Sony and JVC 4K projectors. The Sony lens has a 0.8:1 throw ratio and offers a vertical lens shift of +/- 20%, and allows users to closely stack two projectors. The widest lens Sony offers for this projector is a 0.9:1 ratio. A long throw zoom lens has also been developed for JVC with a 2.1-5.0:1 throw ratio.

Military Simulation Optics

Navitar has experience building custom lenses used in JVC and Sony projectors for military flight simulators. With throw ratios of 0.9:1, 1:1, and 1.2:1, the lenses provide bright, sharp images and perfect color registration to all four corners of the projected image.

Engineering Expertise

We have...

A thorough understanding of:

- Application-specific resolution requirements of planetariums and simulators.
- Relay and non-relay designs.
- Fisheye lenses and F-theta distortion.
- Uniform pixel mapping at edge of images.
- Unique characteristics of different chip sets, color off-sets, and panel size variations in light engines.

Extensive experience with:

- Straight and right-angle mechanics.
- Rectilinear and fisheye design requirements.
- Designing to customer masking requirements.
- Tolerance and sensitivity analyses.

Examples of Recent 2K and 4K Custom Lenses							
Projector	Modulation Transfer Function (MTF)		Relay?	FL (mm)	Surface	F/#	FOV (H)
Barco	75% Axis, 58% Field	@ 66 lp/mm	Relay	30.9	Flat	F/2.5	53.2°
Barco	40% Across Field	@ 66 lp/mm	Relay	11.2	Dome	F/2.5	170.0°
Barco/Christie	65% Across Field	@ 66 lp/mm	Non	17.3	Dome	F/2.5	110.0°
Christie	80% Axis, 60% Field	@ 66 lp/mm	Non	26.4	Dome	F/2.7	68.7°
Christie	75% Axis, 40% Field	@ 66 lp/mm	Non	22	Dome	F/2.7	82.4°
JVC	65% Across Field	@ 73 lp/mm	Relay	18	Dome	F/3.15	100.0°
JVC	68% Across Field	@ 73 lp/mm	Relay	9.66	Dome	F/3.2	175.5°
JVC	78% Axis, 74% Field	@ 73 lp/mm	Relay	30	Flat	F/3.15	53.6°
JVC	35% Axis, 7% Field	@ 73 lp/mm	Zoom	55.5-141.5	Flat	F/3-F/5	28°-11.2°
JVC	73% Axis, 15% Full Shift	@ 68 lp/mm	Non	15.92	Curve	F/3.2	48.0°
JVC	78% Axis, 20% Full Shift	@ 68 lp/mm	Non	19.11	Curve	F/3.2	40.4°
Sony	25% Across Field	@ 60 lp/mm	Relay	19.67	Dome	F/3.2	102.2°
Sony	70% Across Field	@ 73 lp/mm	Relay	19.48	Dome	F/3.15	80.0°
Sony	84% Axis, 78% Field	@ 66 lp/mm	Relay	11.8	Dome	F/2.8	180.0°
Sony	60% Axis, 32% Field	@ 60 lp/mm	Non	27.5	Flat	F/3.2	64.0°
Sony	78% Axis, 65% Field	@ 73 lp/mm	Non	15	Curve	F/2.4	51.3°

Note: Please contact Navitar regarding commercial availability of above lenses.



NuView® Lenses

Replaces the Existing Prime Lens of Your Projector



One Change Is All You Need

NuView lenses replace the existing prime lens of your projector and allow you to use your projector in a variety of applications. NuView lenses are compatible with LCD, DLP, DILA and LCOS projectors.

NuView Long Throw Zoom Lenses

Use a long throw lens to increase projection distance and move your projector farther from the screen. The zoom feature allows you to choose your projection distance and image size by simply rotating the lens. See available lenses and specifications in table below.

NuView Wide Angle Fixed Focal Length Lenses

Use a wide angle lens in rear screen applications or to produce much larger images for front projection. See available lenses and specifications in table below.

NuView Lens Projection Chart

Navitar long throw zoom (MCZ) and fixed focal length (MCL) replacement lenses are listed below with their focal lengths (in both mm and inches) and distance to width ratios for compatible projector panel sizes. Complete Navitar part numbers include a three-digit projector-specific prefix. A complete list of lenses available by projector manufacturer can be found at www.navitar.com.

Part #	Focal Length (mm) (inches)		Panel Sizes								
			0.7 DLP	0.8 LCD	0.99 LCD	1.1 LCD	1.22 LCD	1.3 LCD	1.4 LCD	1.65 LCD	1.8 LCD
Distance to Width Ratio											
Long Throw											
MCZ275	50-70	2.0-2.75	3.5-4.9:1	3.0-4.3:1	2.5-3.5:1	2.1-2.9:1	-	-	-	-	-
MCZ500	70-125	2.75-5.0	4.9-8.8:1	4.3-7.7:1	3.5-6.3:1	2.9-5.1:1	-	2.7-4.8:1	-	-	-
MCZ125	70-125	2.75-5.0	-	-	-	-	2.6-4.6:1	-	2.5-4.4:1	1.9-3.4:1	1.9-3.4:1
MCZ537	114-196	4.5-7.7	-	-	-	-	4.3-7.4:1	-	4.1-7.0:1	3.2-5.5:1	3.2-5.4:1
MCZ087	132-220	5.2-8.7	9.3-15.4:1	8.1-13.5:1	6.5-11.2:1	5.4-9.0:1	-	5.0-8.3:1	-	-	-
MCZ900	150-230	6.0-9.0	10.7-16.1:1	9.2-14.1:1	7.6-11.3:1	6.1-9.4:1	-	5.8-8.6:1	-	-	-
MCZ151	184-314	7.2-12.4	-	-	-	-	6.8-11.6:1	-	6.5-11.0:1	5.0-8.6:1	5.0-8.6:1
MCZ123	187-312	7.4-12.3	-	-	-	7.7-12.8:1	-	7.1-11.8:1	-	-	-
MCZ183*	272-464	10.7-18.3	-	-	-	-	10.7-17.1:1	-	9.6-16.3:1	7.5-12.7:1	7.4-12.7:1
Wide Angle											
MCL1625	16	0.63	1.2:1	1.0:1	0.8:1	0.7:1	-	-	-	-	-
MCL2125	21	0.83	1.5:1	1.3:1	1.1:1	0.9:1	-	0.8:1	-	-	-
MCL1028	25.4	1.0	1.8:1	1.6:1	1.3:1	1.0:1	-	0.9:1	-	-	-
MCL012	30	1.2	2.1:1	1.8:1	1.5:1	1.2:1	-	1.2:1	-	-	-

* Please contact a Navitar sales representative to discuss suitable applications.

ScreenStar® Lenses

Navitar's ScreenStar conversion lenses are placed in front of your projector's standard lens to change image size or throw distance.

- These lenses decrease the overall cost of installation by allowing you to reduce the number of projectors being used, or by selecting a lower cost, less featured projector.

ScreenStar lenses work with LCD, DLP, DILA and LCOS projectors.



Navitar offers table mounts and ceiling mounts for ScreenStar lenses. No mounting options are currently available for the SST300. Please contact your account manager for more information.





SST120 with Table Mount

ScreenStar Conversion Lens Specifications

Wide Angle Lenses

Lens	Part #	Description	Image Conversion	Lens Details
	SSW065	0.65X wide angle converter	50% larger image	Increases picture size by 50% from the same projection distance or maintains the same image size while moving the projector 33% closer to the screen.
	SSW08	0.8X wide angle converter	25% larger image	Increases picture size by 25% from the same projection distance or maintains the same image size while moving the projector 20% closer to the screen.



Telephoto Lenses

	SST120	1.20X telephoto converter	17% smaller image	Reduces picture size by 17% from the same projection distance or keeps the same image size while moving the projector 20% farther away from the screen.
	SST150	1.50X telephoto converter	33% smaller image	Reduces picture size by 33% from the same projection distance or keeps the same image size while moving the projector 50% farther away from the screen.
	SST300*	3.00X telephoto converter	67% smaller image	Reduces picture size by 67% from the same projection distance or keep the same image size while moving the projector three times farther away from the screen

Mini Wide Angle Lenses

	SSC065	0.65X mini wide angle converter	50% larger image	Increases picture size by 50% from the same projection distance or maintains the same image size while moving the projector 33% closer to the screen. Compact and lightweight; ideal for small aperture projectors.
---	--------	---------------------------------	------------------	---

High Definition Lenses

	HD SSW065	0.65X HD wide angle converter	50% larger image	Increases picture size by 50% from the same projection distance. With a large aperture to prevent vignetting, this highly-corrected lens system is optimized for 1080P resolution.
	HD SSW08	0.8X HD wide angle converter	25% larger image	Increases picture size by 25% from the same projection distance. With a large aperture to prevent vignetting, this highly-corrected lens system is optimized for 1080P resolution.

*All lenses include a stabilizing leg *except* the SST300. No mounting options are currently available for the SST300.

System Diagrams

Z
S

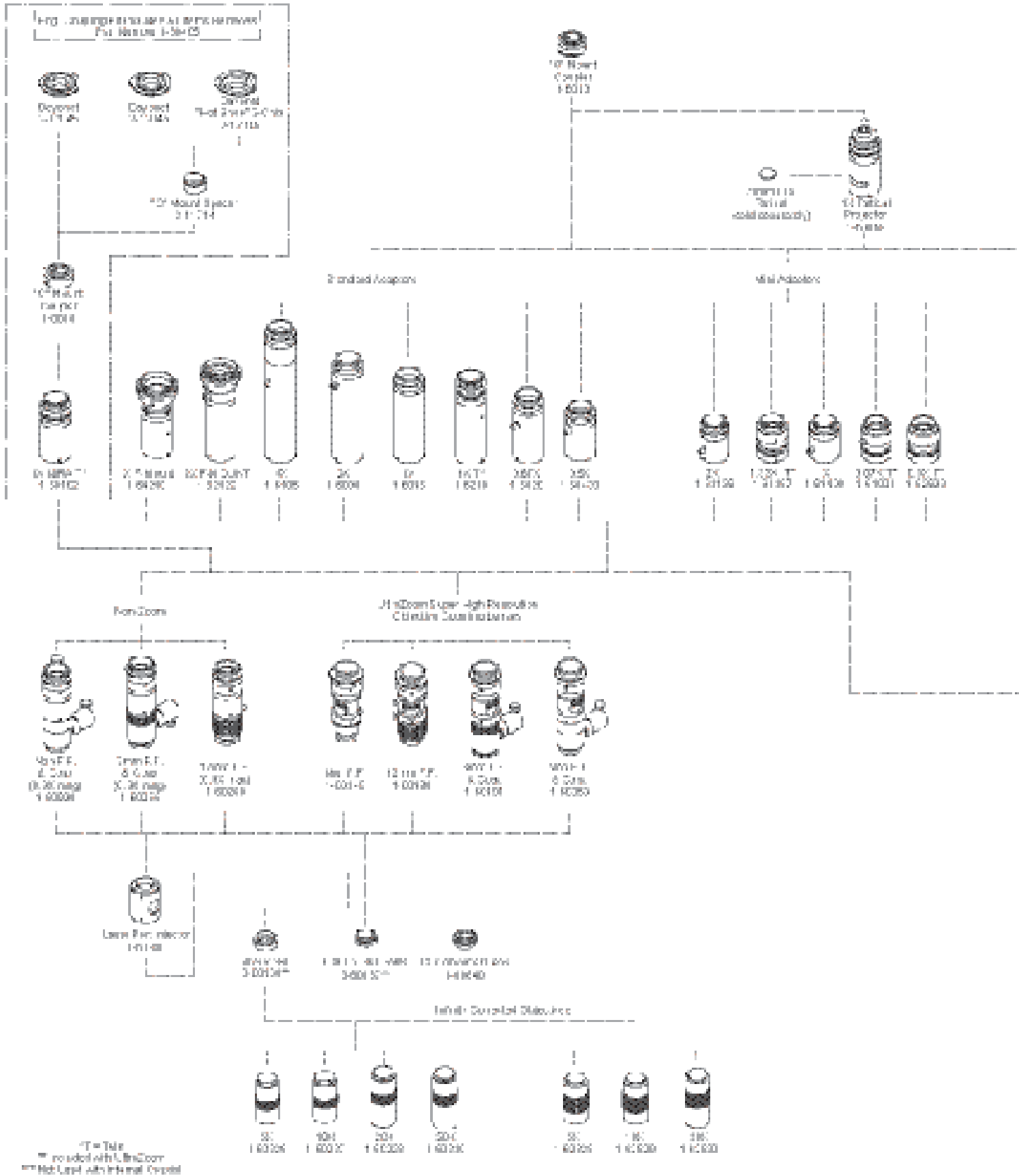

25mm
Microscope
Eye Piece
Co. # 1-80181

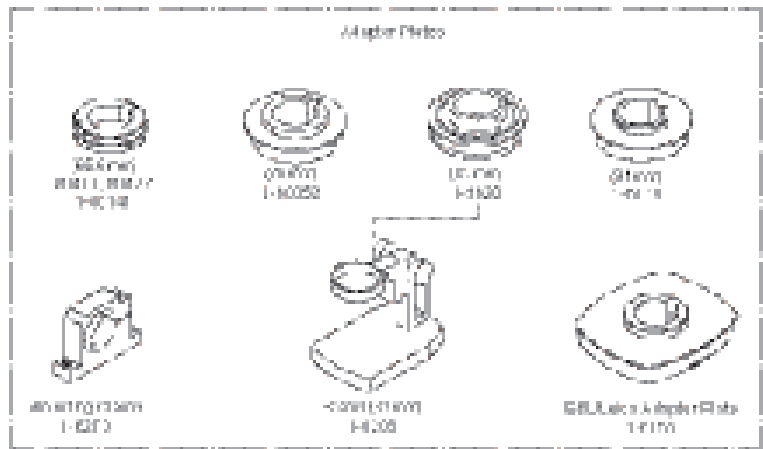

Short Focus

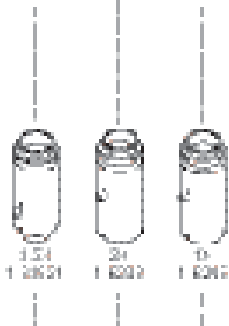

High Power Wide Angle Adapters

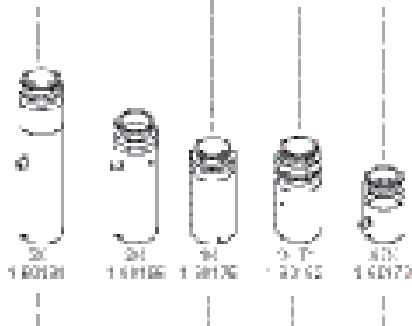

Right Angle Adapters

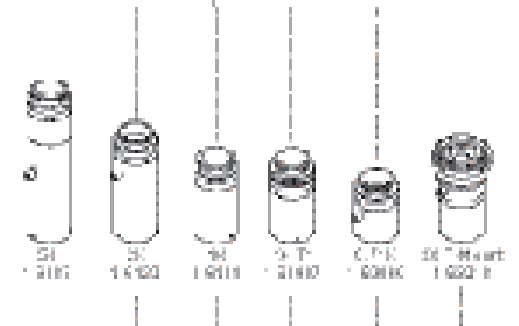

High Magnification



Zoom Lens



Lens/Attachments



IRV Systems

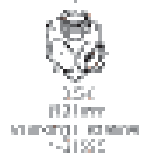

12X Zoom System Diagram

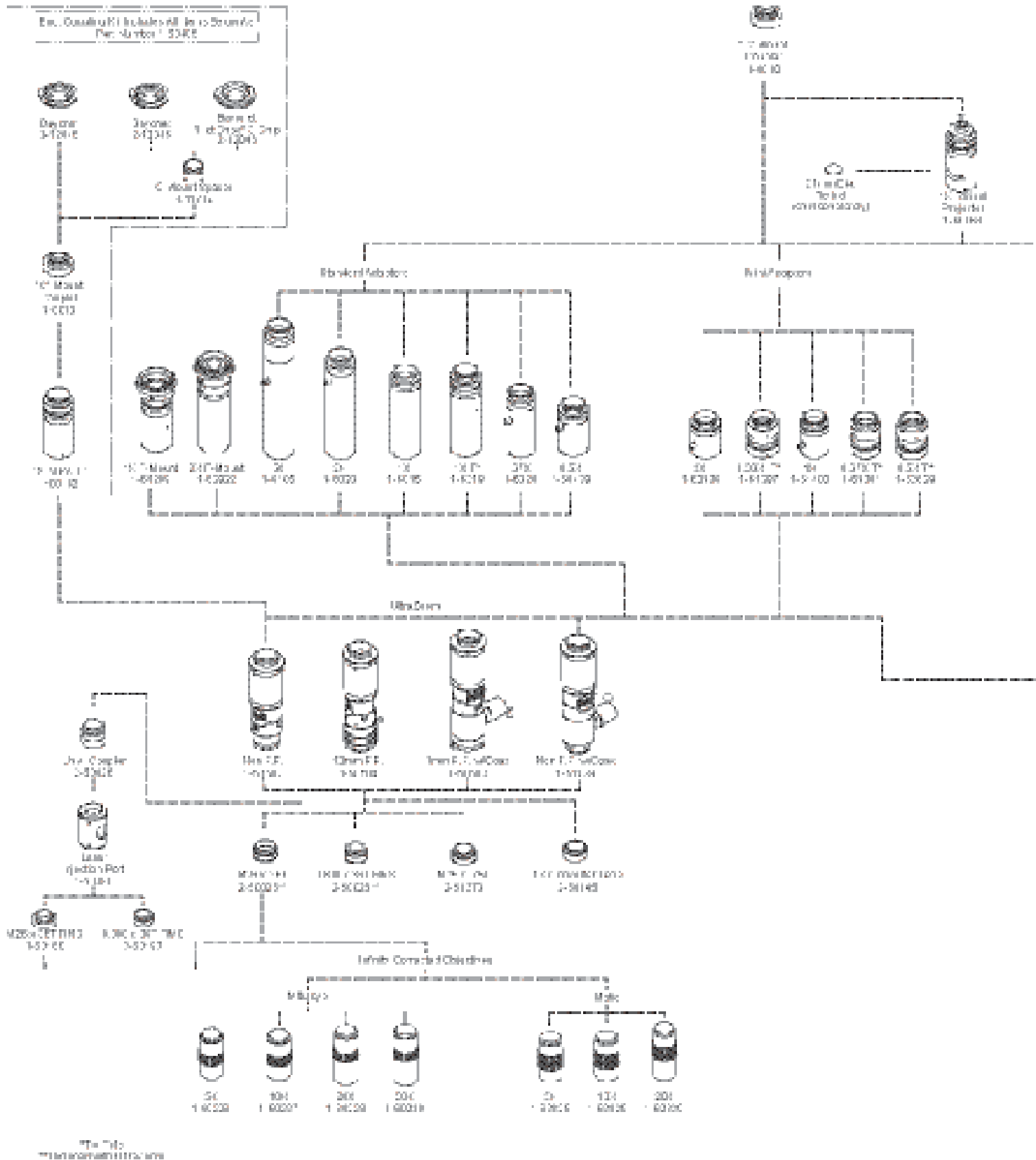

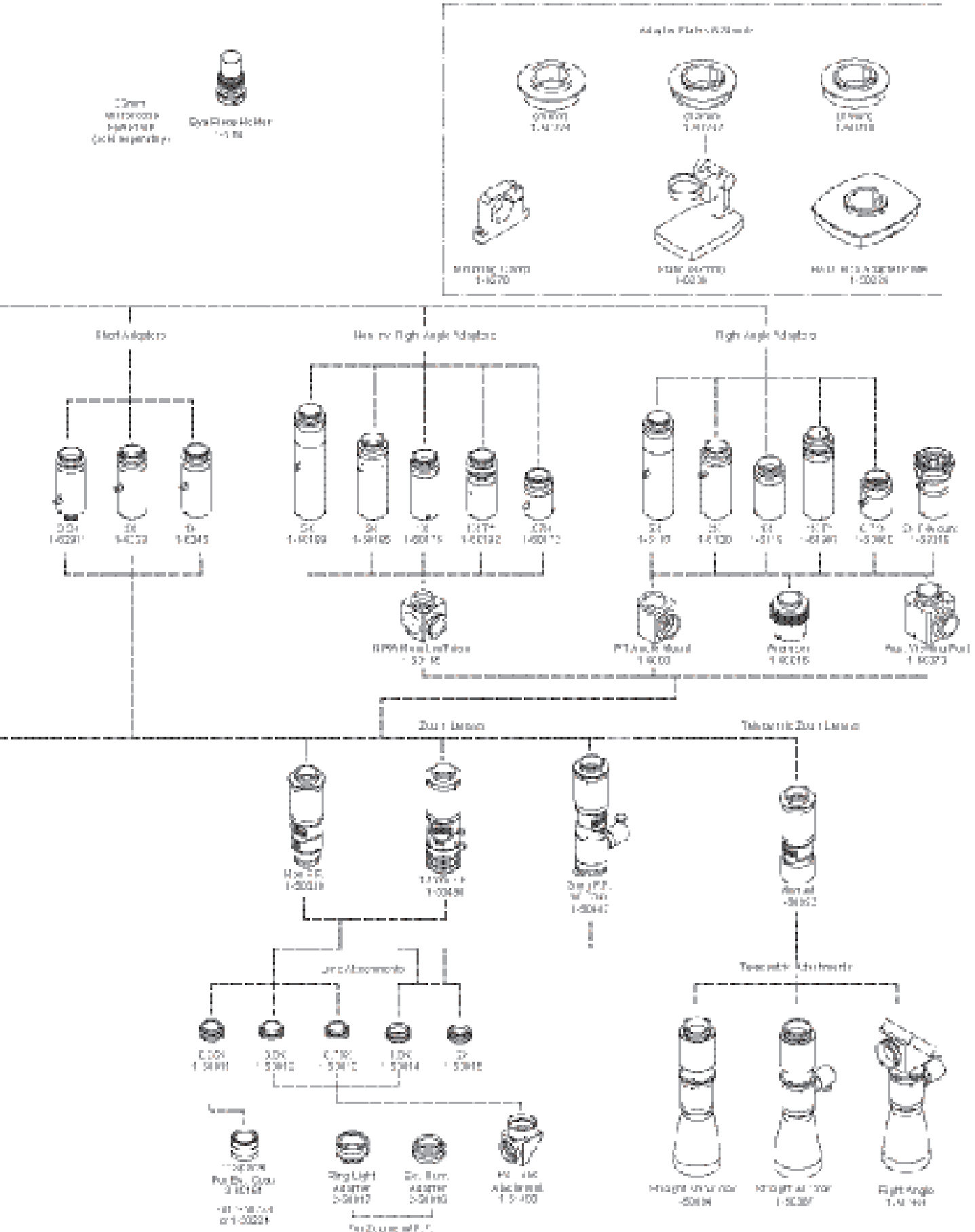

System Diagrams

Precise Eye System Diagram

Adapter Tubes

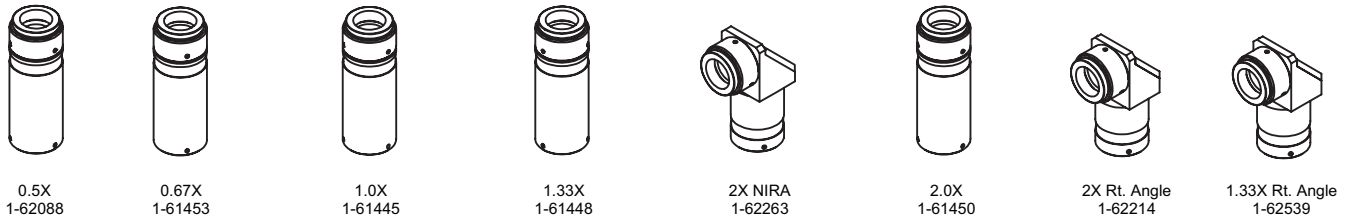

Ultra Body Tubes

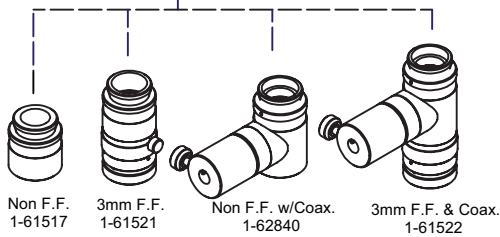

Ultra Motorized Body Tubes

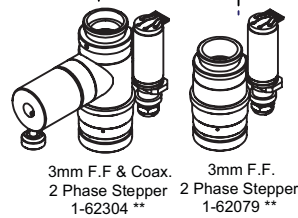

Right Angle Body Tubes

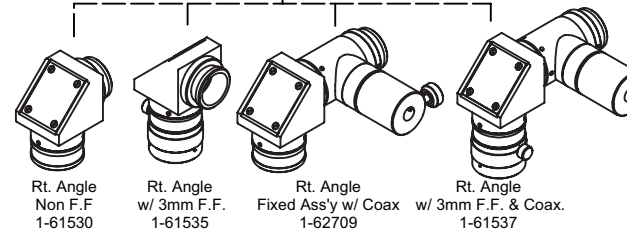

Infinity Corrected Objectives

Mitutoyo

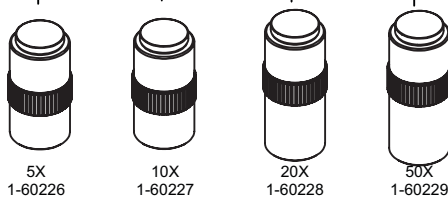

Motic

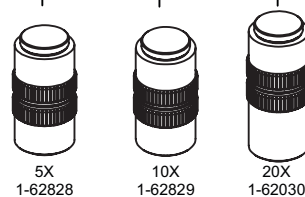

* Included with ULTRA PRECISE EYE

** Items are Special Order (Contact Navitar for Additional Information).

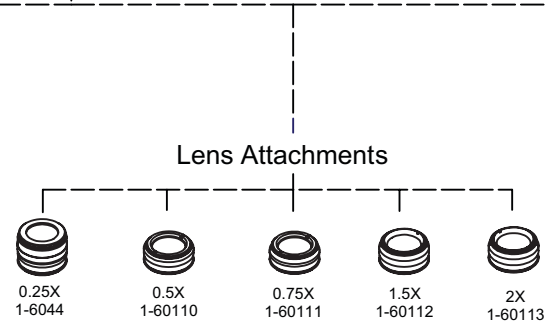
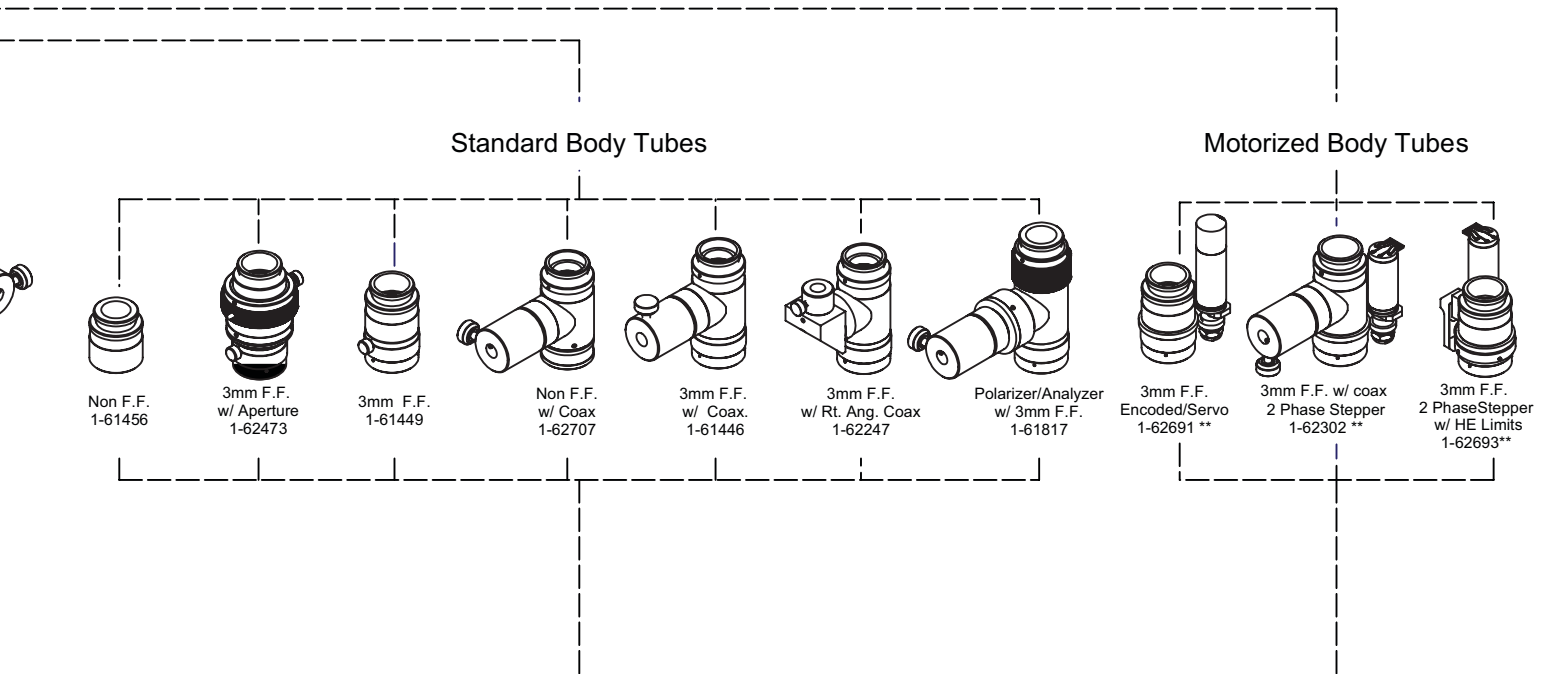
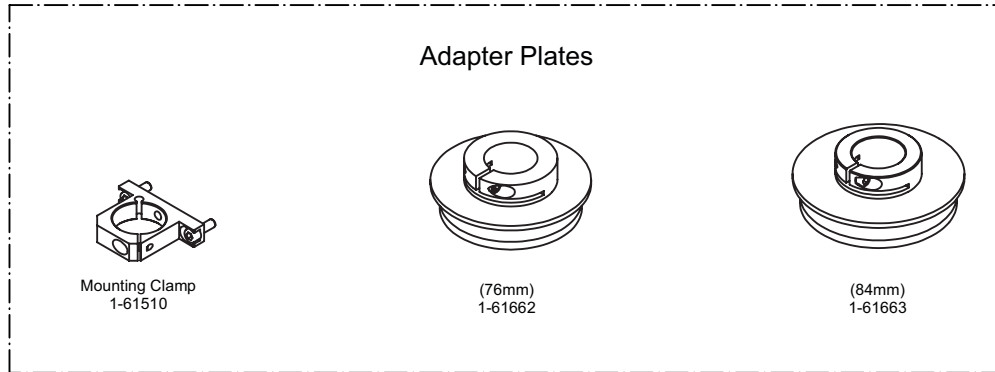

System Diagrams

ZFL System Diagram

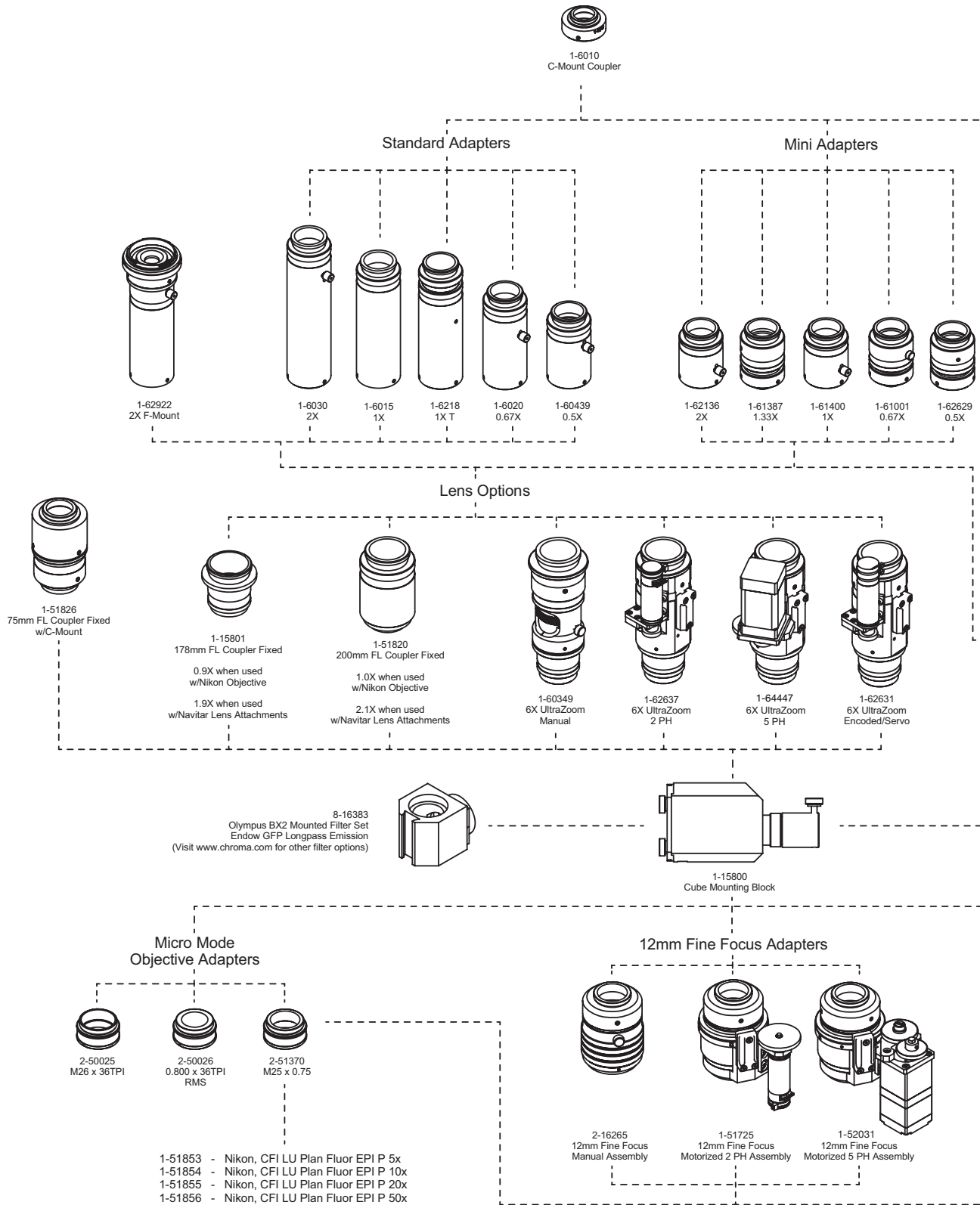

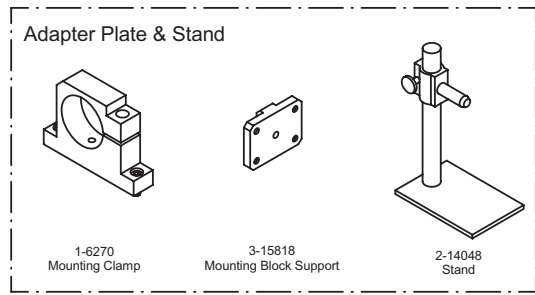

Non-Inv. Right Angle Adapters

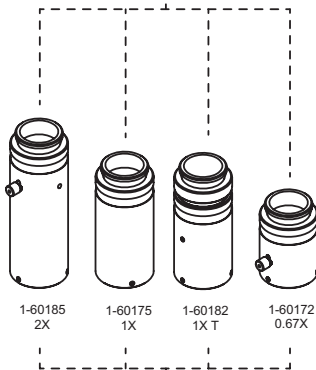

Right Angle Adapters

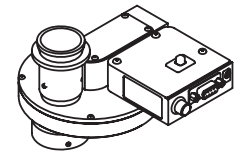
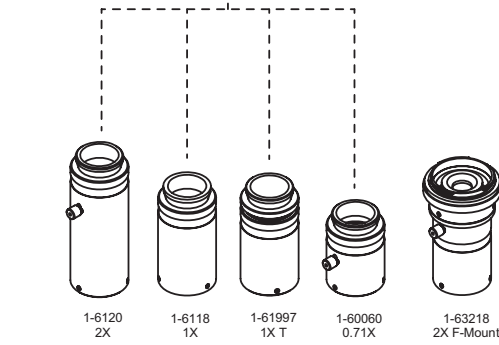

1-64070 Adapter Tube w/Filter Wheel

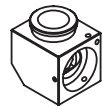

1-60165 NIRA Mount w/Prism

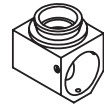

1-6080 Right Angle Mount



1-60816 Analyzer

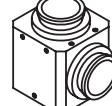

1-60370 Aux. Viewing Port



1-64071 Filter Wheel Adapter

Light Sources

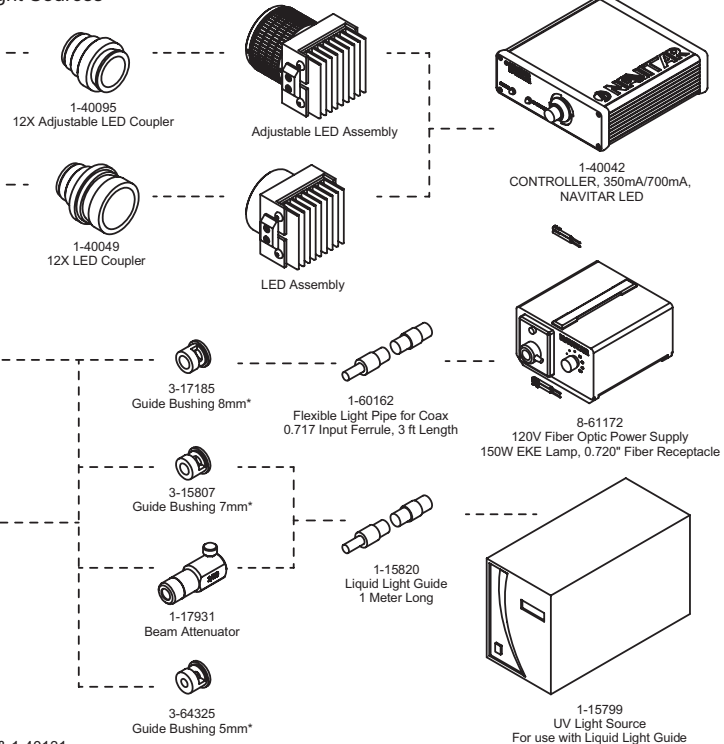

Macro Mode Lens

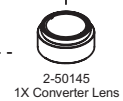

Lens Attachments

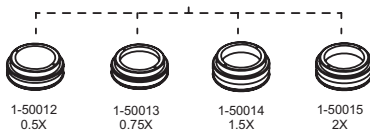

* Included with 1-15800 & 1-40131

Illumination System Diagram

RING LIGHT SYSTEMS

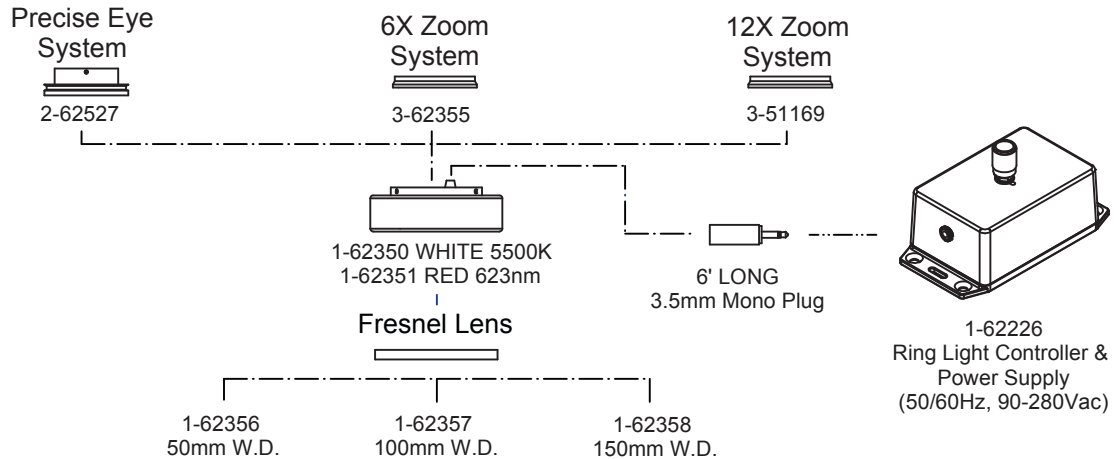

ADJUSTABLE COAXIAL LED ASSEMBLIES

ILLUMINATORS:

- 1-40086 NEUTRAL WHITE (4100K)
- 1-40087 COOL WHITE (6500K)
- 1-40088 WARM WHITE (3100K)
- 1-40089 GREEN (530nm)
- 1-40090 CYAN (505nm)
- 1-40091 BLUE (470nm)
- 1-40092 ROYAL BLUE (447.5nm)
- 1-40106 RED (627nm)
- 1-40093 RED-ORANGE (617nm)
- 1-40094 AMBER (590nm)

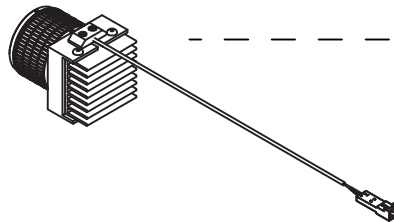

1-40096
6X ADJUSTABLE
LED COUPLER

1-40095
12X ADJUSTABLE
LED COUPLER

COAXIAL LED ASSEMBLIES

ILLUMINATORS:

- 1-40028 NEUTRAL WHITE (4100K)
- 1-40029 COOL WHITE (6500K)
- 1-40030 WARM WHITE (3100K)
- 1-40031 GREEN (530nm)
- 1-40032 CYAN (505nm)
- 1-40033 BLUE (470nm)
- 1-40034 ROYAL BLUE (447.5nm)
- 1-40035 RED (627nm)
- 1-40036 RED-ORANGE (617nm)
- 1-40037 AMBER (590nm)

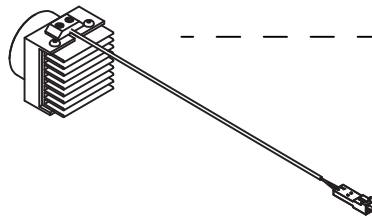

1-40046
6X LED COUPLER

1-40049
12X LED COUPLER

CONTROLLERS

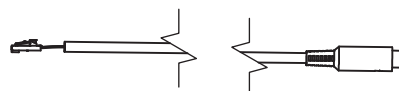

INTERFACE CABLES:

- 1-40181 LED CABLE (.5 meter)
- 1-40182 LED CABLE (1 meter)
- 1-40183 LED CABLE (2 meters)
- 1-40184 LED CABLE (3 meters)

1-40042
350mA/700 mA
DESKTOP CONTROLLER

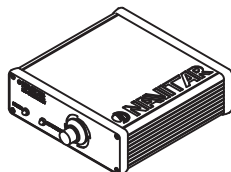

1-40045
350mA/700mA
FLANGE MOUNT CONTROLLER

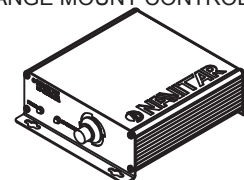

DIC Module System Diagram

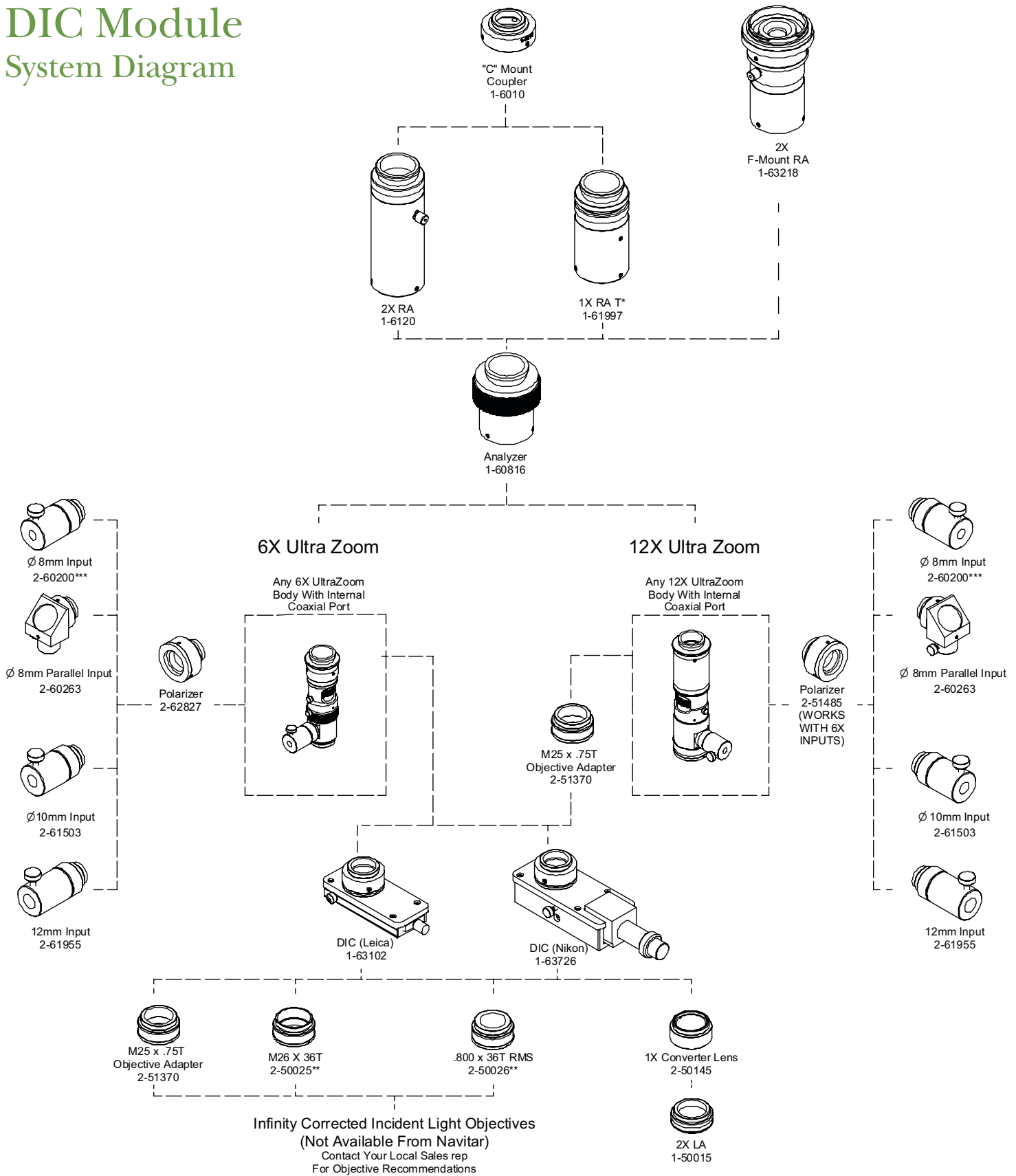

*T = Tele

** Included With 12X UltraZooms

*** Included With Manual 6000 UltraZooms

System Diagrams

Dual View Lens System Diagram

Adapter Tube Required
(1-6015 or 1-6218 suggested)

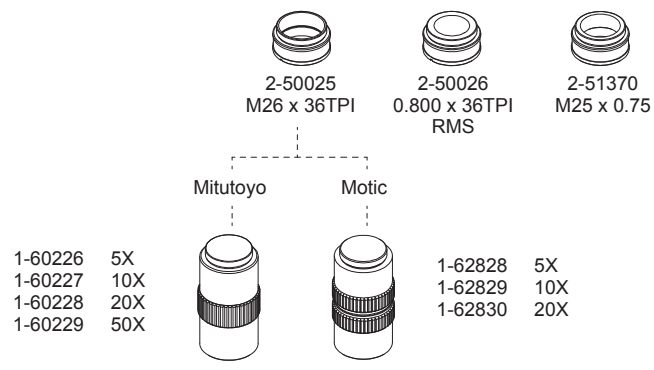
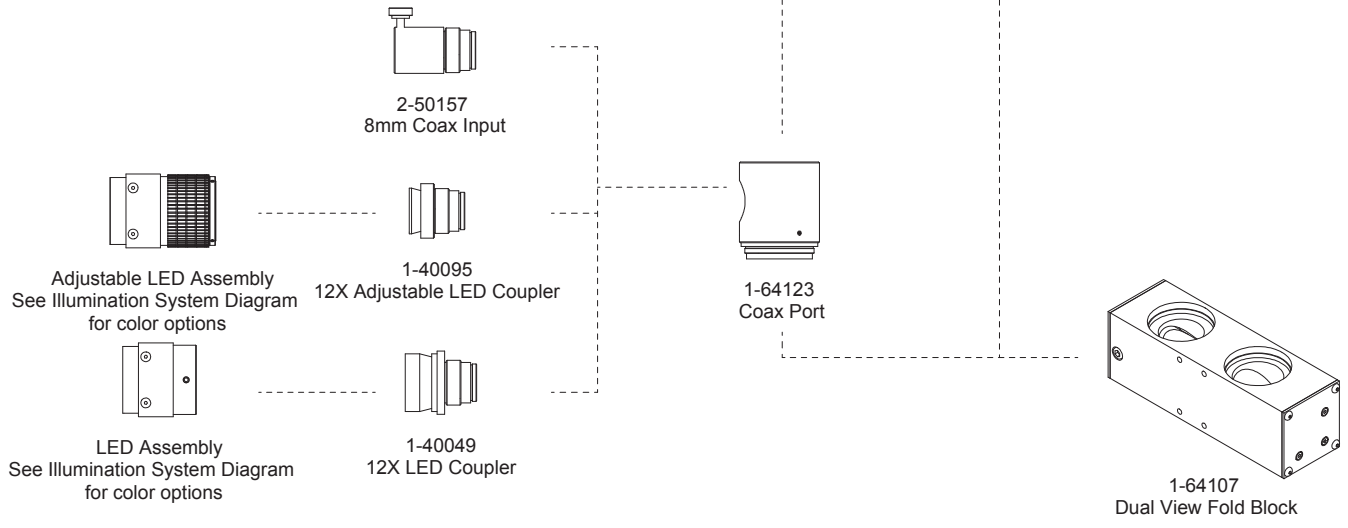
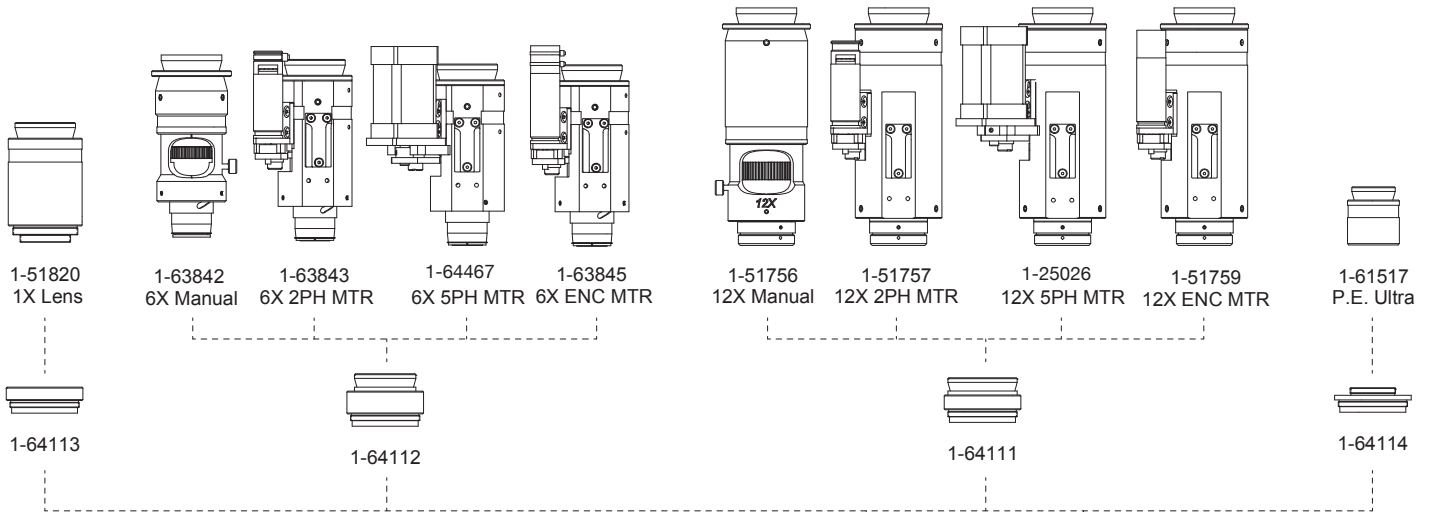

Note: Factory alignment of all parts is required.

Adapter Tube Required
(1-6015 or 1-6218 suggested)

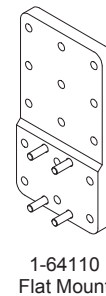
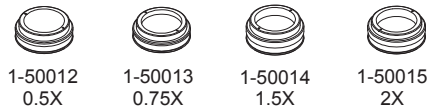
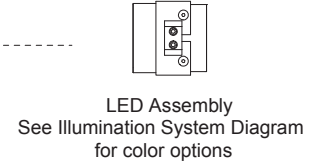
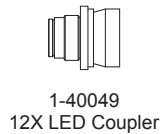
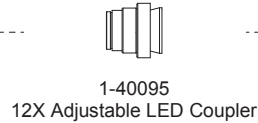
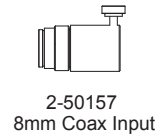
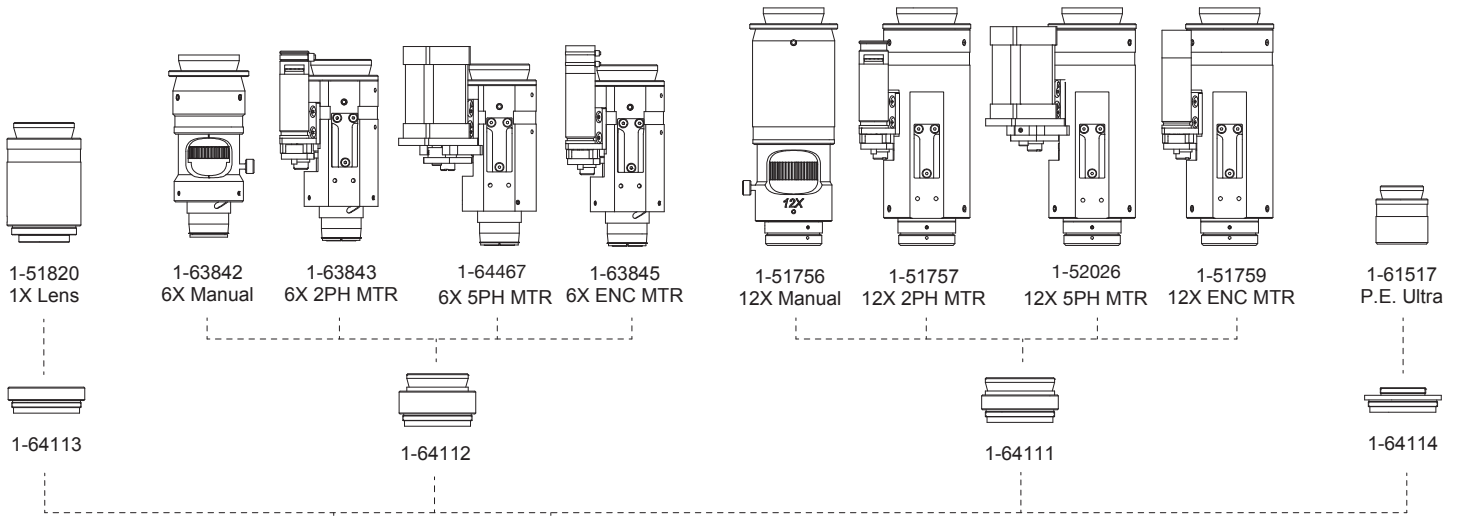

System Diagrams

1X Fixed Lens

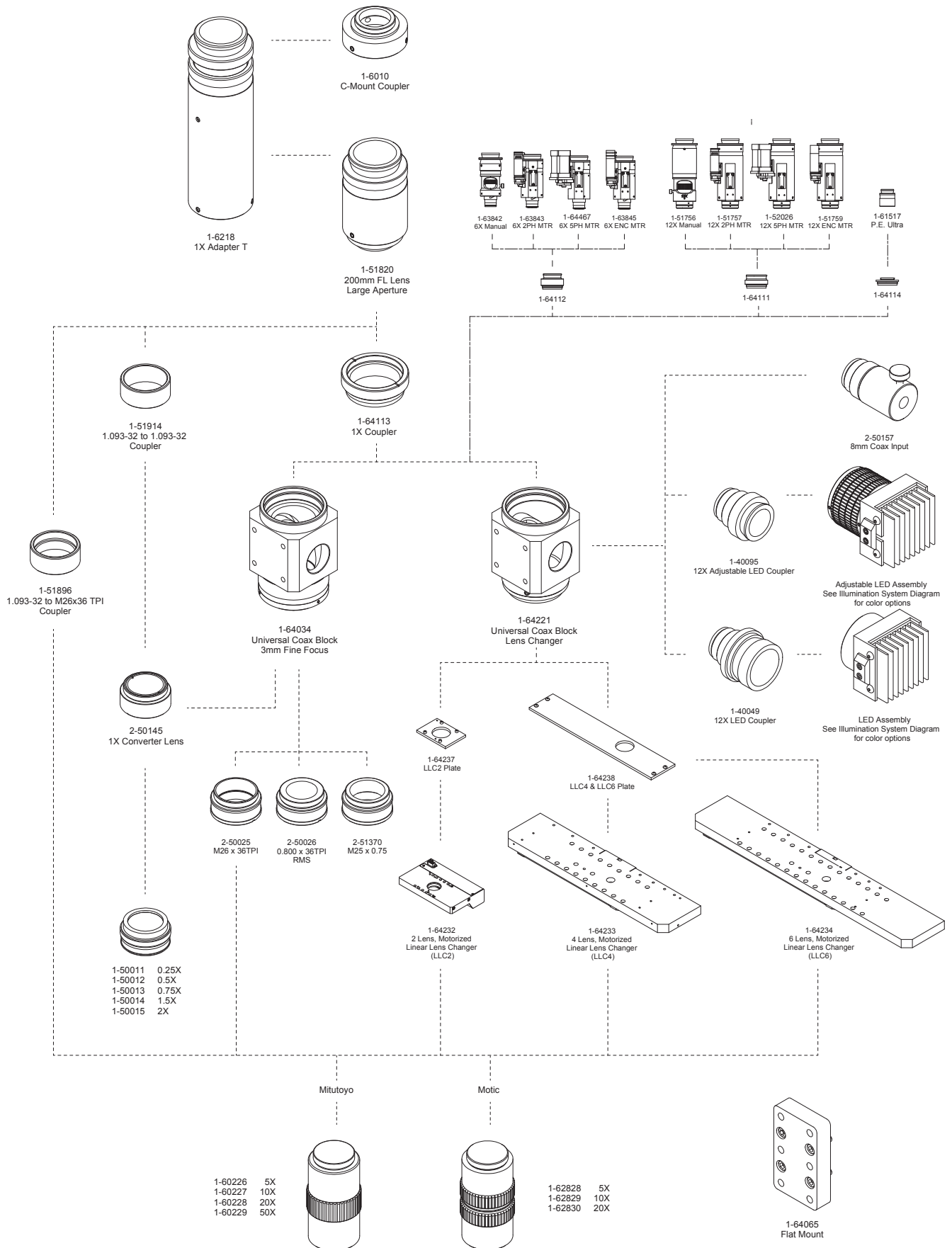

Reference Information

Matrices and Specifications
Resources

Matrices and Specifications

Zoom 6000 Field of View Matrix In mm at Nominal Working Distance

Lens Attachment	Working Distance (mm)	Camera Format/Parameters	.5X Adapter Low - High	.67X Adapter Low - High	1X Adapter Low - High	1.33X Adapter Low - High	2X Adapter Low - High	3.3X Adapter Low - High	5X Adapter Low - High	Resolve Limit (microns) Low-High	Depth of Field (mm) Low-High
0.25X 0.006 - 0.018 1-6044	356 (nominal)	Mag.	0.09X - 0.56X	0.12X - 0.75X	0.18X - 1.13X	0.24X - 1.5X	0.35X - 2.25X	0.59X - 3.73X	0.88X - 5.62X	55.56 - 18.52	13.89 - 1.54
		Field 1/4"	45.70 - 7.12	34.03 - 5.33	22.85 - 3.56	17.18 - 2.68	11.42 - 1.78	6.92 - 1.08	4.54 - 0.72	55.56 - 18.52	13.89 - 1.54
	220-390 (1) W.D. range	Field 1/3"	68.64 - 10.64	51.12 - 8.04	34.32 - 5.32	25.80 - 4.0	17.16 - 2.66	10.4 - 1.61	6.88 - 1.08	55.56 - 18.52	13.89 - 1.54
		Field 1/2"	91.36 - 14.16	68.06 - 10.66	45.68 - 7.08	34.34 - 5.32	22.84 - 3.54	13.84 - 2.14	9.12 - 1.44	55.56 - 18.52	13.89 - 1.54
		Field 2/3"	91.40 - 19.52	93.62 - 14.66	62.84 - 9.76	47.25 - 7.34	31.42 - 4.88	19.04 - 2.96	12.56 - 1.96	55.56 - 18.52	13.89 - 1.54
0.5X 0.011 - 0.035 1-60110	175 (nominal)	Mag.	0.18X - 1.13X	0.24X - 1.50X	0.35X - 2.25X	0.46X - 2.99X	0.70X - 4.50X	1.16X - 7.4X	1.75X - 11.25X	30.30 - 9.52	4.13 - 0.41
		Field 1/4"	22.85 - 3.56	17.02 - 2.66	11.42 - 1.78	8.59 - 1.34	5.71 - 0.89	3.46 - 0.54	2.28 - 0.36	30.30 - 9.52	4.13 - 0.41
	143-187 (1) W.D. range	Field 1/3"	34.32 - 5.32	25.56 - 4.0	17.16 - 2.67	12.90 - 2.01	8.58 - 1.33	5.20 - 0.81	3.43 - 0.53	30.30 - 9.52	4.13 - 0.41
		Field 1/2"	45.68 - 7.08	34.03 - 5.33	22.85 - 3.56	17.18 - 2.68	11.42 - 1.77	6.92 - 1.08	4.57 - 0.71	30.30 - 9.52	4.13 - 0.41
		Field 2/3"	45.70 - 9.76	46.81 - 7.33	31.43 - 4.89	23.63 - 3.68	15.71 - 2.44	9.52 - 1.48	6.29 - 0.98	30.30 - 9.52	4.13 - 0.41
0.75X 0.017 - 0.053 1-60111	113 (nominal)	Mag.	0.27X - 1.69X	0.35X - 2.25X	0.53X - 3.38X	0.70X - 4.49X	1.05X - 6.75X	1.75X - 11.15X	2.63X - 16.88X	19.60 - 6.28	1.73 - 0.18
		Field 1/4"	15.22 - 2.38	11.34 - 1.78	7.61 - 1.19	5.72 - 0.89	3.81 - 0.59	2.31 - 0.34	1.52 - 0.24	19.60 - 6.28	1.73 - 0.18
	100-119 (1) W.D. range	Field 1/3"	22.86 - 3.56	17.04 - 2.67	11.43 - 1.78	8.59 - 1.34	5.72 - 0.89	3.46 - 0.54	2.29 - 0.35	19.60 - 6.28	1.73 - 0.18
		Field 1/2"	30.46 - 4.74	22.69 - 3.56	15.23 - 2.37	11.45 - 1.78	7.62 - 1.19	4.62 - 0.72	3.05 - 0.47	19.60 - 6.28	1.73 - 0.18
		Field 2/3"	30.50 - 6.52	31.21 - 4.89	20.95 - 3.26	15.75 - 2.45	10.48 - 1.63	6.35 - 0.99	4.19 - 0.65	19.60 - 6.28	1.73 - 0.18
None 0.023 - 0.071	92 (nominal)	Mag.	0.35X - 2.25X	0.47X - 3.00X	0.70X - 4.50X	0.93X - 5.89X	1.40X - 9.00X	2.31X - 14.85X	3.50X - 22.50X	14.50 - 4.70	0.95 - 0.10
		Field 1/4"	11.42 - 1.78	8.51 - 1.33	5.71 - 0.89	4.29 - 0.67	2.86 - 0.45	1.73 - 0.27	1.14 - 0.18	14.50 - 4.70	0.95 - 0.10
	81-93 (1) W.D. range	Field 1/3"	17.16 - 2.67	12.77 - 2.01	8.58 - 1.33	6.45 - 1.0	4.29 - 0.67	2.60 - 0.40	1.72 - 0.27	14.50 - 4.70	0.95 - 0.10
		Field 1/2"	22.85 - 3.56	17.01 - 2.67	11.42 - 1.77	8.59 - 1.33	5.71 - 0.89	3.46 - 0.54	2.28 - 0.36	14.50 - 4.70	0.95 - 0.10
		Field 2/3"	22.90 - 4.89	23.40 - 3.65	15.71 - 2.44	11.81 - 1.83	7.86 - 1.22	4.76 - 0.74	3.14 - 0.49	14.50 - 4.70	0.95 - 0.10
1.5X 0.034 - 0.106 1-60112	51 (nominal)	Mag.	0.53X - 3.38X	0.71X - 4.50X	1.05X - 6.75X	1.40 - 8.98	2.10X - 13.50X	3.47X - 22.28X	5.25X - 33.75X	9.80 - 3.14	0.43 - 0.04
		Field 1/4"	7.61 - 1.19	5.67 - 0.89	3.81 - 0.59	2.86 - 0.44	1.91 - 0.30	1.15 - 0.18	0.76 - 0.12	9.80 - 3.14	0.43 - 0.04
	48-52 (1) W.D. range	Field 1/3"	11.43 - 1.78	8.52 - 1.33	5.72 - 0.89	4.3 - 0.67	2.86 - 0.44	1.73 - 0.27	1.14 - 0.18	9.80 - 3.14	0.43 - 0.04
		Field 1/2"	15.23 - 2.37	11.34 - 1.77	7.62 - 1.19	5.73 - 0.89	3.81 - 0.59	2.31 - 0.36	1.52 - 0.24	9.80 - 3.14	0.43 - 0.04
		Field 2/3"	15.00 - 3.26	15.60 - 2.44	10.48 - 1.63	7.88 - 1.22	5.24 - 0.81	3.18 - 0.49	2.10 - 0.33	9.80 - 3.14	0.43 - 0.04
2.0X 0.040 - 0.142 1-60113	36 (nominal)	Mag.	0.70X - 4.50X	0.94X - 6.00X	1.40X - 9.00X	1.86X - 11.97X	2.80X - 18.00X	4.62X - 29.7X	7.00X - 45.00X	7.24 - 2.34	0.24 - 0.02
		Field 1/4"	5.71 - 0.89	4.26 - 0.67	2.86 - 0.45	2.15 - 0.34	1.43 - 0.23	0.87 - 0.14	0.57 - 0.09	7.24 - 2.34	0.24 - 0.02
	34-37 (1) W.D. range	Field 1/3"	8.58 - 1.33	6.39 - 1.00	4.29 - 0.67	3.22 - 0.50	2.15 - 0.33	1.30 - 0.14	0.86 - 0.13	7.24 - 2.34	0.24 - 0.02
		Field 1/2"	11.42 - 1.77	8.51 - 1.33	5.71 - 0.89	4.29 - 0.67	2.86 - 0.44	1.73 - 0.27	1.14 - 0.18	7.24 - 2.34	0.24 - 0.02
		Field 2/3"	11.40 - 2.44	11.70 - 1.83	7.86 - 1.22	5.91 - 0.92	3.93 - 0.61	2.38 - 0.37	1.57 - 0.24	7.24 - 2.34	0.24 - 0.02

Notes:
 The above fields of view are measured diagonally in millimeters (Horizontal = Diagonal x 0.8 and Vertical = Diagonal x 0.6).
 (1) Working distance range when using 12 mm fine focus. Field of view will change with shorter or longer working distances.
 NA varies depending in system magnification.

Zoom 6000 UltraZoom Field of View Matrix

1-60190, 1-60191, 1-60349 and 1-60350 (In mm)

Objective Lens (Mitutoyo) Long WD	W.D.	Camera Format/Parameters	1X Adapter Low - High	1.33X Adapter Low - High	2X Adapter Low - High	3.5X Adapter Low - High
5X 0.14 NA* 1-60226	34	Mag.	1.74X - 11.43X	2.3X - 15.0X	3.48X - 22.86X	6.1X - 39.4X
		Sensor 1/4"	2.30 - 0.35	1.74 - 0.26	1.15 - 0.17	0.65 - 0.1
		Sensor 1/3"	3.45 - 0.52	2.61 - 0.40	1.72 - 0.26	0.98 - 0.15
		Sensor 1/2"	(1) 4.05 - 0.70	3.48 - 0.54	2.30 - 0.35	1.31 - 0.20
		Sensor 2/3"	(1) 4.02 - 0.96	4.0 - 0.74	3.16 - 0.48	1.80 - 0.28
10X 0.28 NA* 1-60227	33	Mag.	3.48X - 22.86X	4.63X - 29.9X	6.96X - 45.72X	12.3X - 78.8X
		Sensor 1/4"	1.15 - 0.17	0.86 - 0.13	0.57 - 0.09	0.33 - 0.05
		Sensor 1/3"	1.72 - 0.26	1.30 - 0.20	0.86 - 0.13	0.49 - 0.08
		Sensor 1/2"	(1) 2.10 - 0.35	1.73 - 0.27	1.15 - 0.17	0.66 - 0.10
		Sensor 2/3"	(1) 2.10 - 0.48	2.10 - 0.37	1.58 - 0.24	0.9 - 0.14
20X 0.42 NA* 1-60228	20	Mag.	6.96X - 45.72X	9.3X - 59.9X	13.92X - 91.40X	24.5X - 157.6X
		Sensor 1/4"	0.57 - 0.09	0.43 - 0.07	0.29 - 0.04	0.16 - 0.03
		Sensor 1/3"	0.86 - 0.13	0.65 - 0.10	0.43 - 0.07	0.25 - 0.04
		Sensor 1/2"	(1) 1.0 - 0.17	0.86 - 0.14	0.57 - 0.09	0.33 - 0.05
		Sensor 2/3"	(1) 1.03 - 0.24	1.0 - 0.19	0.79 - 0.12	0.45 - 0.07
50X 0.55 NA* 1-60229	13	Mag.	17.40X - 114.30X	23X-150X	34.80X - 228.60X	61X - 393.8X
		Sensor 1/4"	0.23 - 0.03	0.17 - 0.03	0.11 - 0.02	0.07 - 0.01
		Sensor 1/3"	0.30 - 0.05	0.26 - 0.04	0.17 - 0.03	0.10 - 0.015
		Sensor 1/2"	(1) 0.31 - 0.07	0.30 - 0.05	0.23 - 0.04	0.13 - 0.02
		Sensor 2/3"	(1) 0.30 - 0.10	0.30 - 0.07	(1) 0.30 - 0.05	0.18 - 0.03

(1) Entire zoom range is not used.

*NA at full zoom. NA varies with zoom settings.

Zoom 6000 Field of View Matrix for Internal Coaxial Zoom

1-60123 (In mm at Nominal Working Distance)

Lens Attachment	W.D.	Camera Format/Parameters	.5X Adapter Low - High	.67X Adapter Low - High	1X Adapter Low - High	1.33X Adapter Low - High	2X Adapter Low - High	3.5X Adapter Low - High	5X Adapter Low - High
None 0.023- 0.071	92 (nominal) 90-93 (1) W.D. range	Mag.	0.35X - 2.25X	0.47X - 3.00X	0.70X - 4.50X	.93X - 6.0X	1.40X - 9.00X	2.45X - 15.75X	3.50X - 22.50X
		Sensor 1/4"	11.43 - 1.78	8.51 - 1.33	5.71 - 0.89	4.3X - 0.67	2.86 - 0.45	1.63 - 0.25	1.14 - 0.18
		Sensor 1/3"	(2) 11.10 - 2.67	(2) 11.40 - 2.01	8.58 - 1.33	6.45 - 1.0	4.29 - 0.67	2.45 - 0.38	1.72 - 0.27
		Sensor 1/2"	(2) 11.20 - 3.56	(2) 11.46 - 2.62	11.42 - 1.77	8.6 - 1.33	5.71 - 0.89	3.27 - 0.51	2.28 - 0.36
		Sensor 2/3"	(2) 11.06 - 4.89	(2) 11.54 - 3.60	11.40 - 2.44	11.0 - 1.83	7.86 - 1.22	4.49 - 0.7	3.14 - 0.49
1.5X 0.034- 0.104 1-60112	51 (nominal) 51-53 (1) W.D. range	Mag.	0.53X - 3.38X	0.71X - 4.50X	1.05X - 6.75X	1.4X - 9.0X	2.10X - 13.50X	3.7X - 23.6X	5.25X - 33.75X
		Sensor 1/4"	7.62 - 1.18	5.67 - 0.89	3.81 - 0.59	2.85 - 0.44	1.91 - 0.30	1.08 - 0.17	0.76 - 0.12
		Sensor 1/3"	11.32 - 1.78	8.52 - 1.33	5.72 - 0.89	4.29 - 0.67	2.86 - 0.44	1.62 - 0.25	1.14 - 0.18
		Sensor 1/2"	(2) 11.20 - 2.37	11.34 - 1.77	7.62 - 1.19	5.71 - 0.89	3.81 - 0.59	2.16 - 0.34	1.52 - 0.24
		Sensor 2/3"	(2) 11.2 - 3.25	(2) 11.20 - 2.44	10.48 - 1.63	7.86 - 1.22	5.24 - 0.81	2.97 - 0.47	2.10 - 0.33
2.0X 0.046- 0.141 1-60113	36 (nominal) 36-37 (1) W.D. range	Mag.	0.70X - 4.50X	0.94X - 6.00X	1.40X - 9.00X	1.86X-12.0X	2.80X - 18.00X	4.9X-31.5X	7.00X - 45.00X
		Sensor 1/4"	5.71 - 0.89	4.26 - 0.67	2.86 - 0.45	2.15 - 0.33	1.43 - 0.23	0.82 - 0.13	0.57 - 0.09
		Sensor 1/3"	8.57 - 1.33	6.39 - 1.00	4.29 - 0.67	3.22 - 0.5	2.15 - 0.33	1.22 - 0.19	0.86 - 0.13
		Sensor 1/2"	(2) 11.2 - 1.77	8.51 - 1.33	5.71 - 0.89	4.30 - 0.67	2.86 - 0.44	1.63 - 0.25	1.14 - 0.18
		Sensor 2/3"	(2) 11.2 - 2.44	(2) 11.7 - 1.83	7.86 - 1.22	5.91 - 0.92	3.93 - 0.61	2.24 - 0.35	1.57 - 0.24

Notes:

The internal coax will illuminate a circular area of about 11 mm in diameter. Any field of view larger than 11 mm will have darkened corners.

Low power lens attachments can be used but produce increasing vignetting. (1) Working distance range when using 3 mm fine focus. (2) Entire zoom range is not used.

Matrices and Specifications

12X Zoom Field of View Matrix (In mm)

Lens Attachment	Working Distance	Camera Formats/Parameters	0.5X Adapter Low-High	0.67X Adapter Low-High	1X Adapter Low-High	1.33X Adapter Low-High	2X Adapter Low-High	3.3X Adapter Low-High	Resolve Limit (Microns) Low-High	Depth of Field (mm) Low-High
0.25X (2)0.005 - 0.025 NA 1-50011	341	Mag.	0.07X - 0.87X	0.10X - 1.20X	0.15X - 1.75X	0.19X - 2.33X	0.29X - 3.50X	0.50X - 5.78X	66.66 - 13.34	20.00 - 0.80
		Field 1/4"	57.14 - 4.59	41.16 - 3.40	27.60 - 2.28	21.05 - 1.72	13.9 - 1.14	8.36 - 0.69	66.66 - 13.34	20.00 - 0.80
		Field 1/3"	85.71 - 6.89	61.73 - 5.10	41.38 - 3.42	31.57 - 2.57	20.69 - 1.71	12.54 - 1.04	66.66 - 13.34	20.00 - 0.80
		Field 1/2"	—	82.32 - 6.80	55.16 - 4.56	42.10 - 3.43	27.58 - 2.28	16.72 - 1.38	66.66 - 13.34	20.00 - 0.80
		Field 2/3"	—	(1) 72.00 - 9.35	75.88 - 6.28	57.89 - 4.72	37.94 - 3.14	22.99 - 1.90	66.66 - 13.34	20.00 - 0.80
0.5X 0.009 - 0.051 N.A. 1-50012	165	Mag.	0.14X - 1.75X	0.20X - 2.40X	0.29X - 3.50X	0.39X - 4.66X	0.58X - 7.00X	0.96X - 11.55X	37.04 - 6.66	6.17 - 0.19
		Field 1/4"	28.57 - 2.28	20.58 - 1.70	13.79 - 1.14	10.25 - 0.86	6.90 - 0.76	4.18 - 0.35	37.04 - 6.66	6.17 - 0.19
		Field 1/3"	42.85 - 3.42	30.87 - 2.55	20.69 - 1.71	15.38 - 1.29	10.34 - 0.86	6.27 - 0.52	37.04 - 6.66	6.17 - 0.19
		Field 1/2"	—	41.16 - 3.40	27.58 - 2.28	20.51 - 1.72	13.79 - 1.14	8.36 - 0.69	37.04 - 6.66	6.17 - 0.19
		Field 2/3"	—	(1) 36.0 - 4.68	37.94 - 3.14	28.20 - 2.36	18.97 - 1.57	11.50 - 0.95	37.04 - 6.66	6.17 - 0.19
0.75X 0.014 - 0.076 N.A. 1-50013	108	Mag.	0.22X - 2.62X	0.29X - 3.50X	0.44X - 5.30X	0.58X - 6.98X	0.87X - 10.50X	1.45X - 17.49X	23.80 - 4.44	2.55 - 0.09
		Field 1/4"	18.18 - 1.52	13.72 - 1.14	9.19 - 0.76	6.89 - 0.57	4.60 - 0.38	2.78 - 0.23	23.80 - 4.44	2.55 - 0.09
		Field 1/3"	27.27 - 2.29	20.58 - 1.70	13.79 - 1.14	10.34 - 0.85	6.89 - 0.57	4.18 - 0.35	23.80 - 4.44	2.55 - 0.09
		Field 1/2"	—	27.44 - 2.27	18.34 - 1.52	13.79 - 1.14	9.19 - 0.76	5.56 - 0.46	23.80 - 4.44	2.55 - 0.09
		Field 2/3"	—	(1) 24.30 - 3.12	25.30 - 2.09	18.96 - 1.57	12.64 - 1.05	7.67 - 0.63	23.80 - 4.44	2.55 - 0.09
None 0.019 - 0.101 N.A.	86	Mag.	0.29X - 3.49X	0.39X - 4.70X	0.58X - 7.00X	0.77X - 9.31X	1.16X - 14.00X	1.91X - 23.1X	18.52 - 3.34	1.39 - 0.05
		Field 1/4"	13.79 - 1.14	10.29 - 0.85	6.90 - 0.57	5.19 - 0.43	3.45 - 0.29	2.09 - 0.17	18.52 - 3.34	1.39 - 0.05
		Field 1/3"	20.69 - 1.72	15.44 - 1.28	10.34 - 0.86	7.79 - 0.64	5.18 - 0.43	3.13 - 0.26	18.52 - 3.34	1.39 - 0.05
		Field 1/2"	—	20.58 - 1.70	13.79 - 1.14	10.39 - 0.86	6.90 - 0.57	4.18 - 0.35	18.52 - 3.34	1.39 - 0.05
		Field 2/3"	—	(1) 18.20 - 2.34	18.97 - 1.57	14.28 - 1.18	9.49 - 0.78	5.75 - 0.48	18.52 - 3.34	1.39 - 0.05
1.5X 0.028 - 0.151 N.A. 1-50014	50	Mag.	0.43X - 5.23X	0.58X - 7.00X	0.87X - 10.50X	1.16X - 14.0X	1.74X - 21.00X	2.87X - 34.65X	12.34 - 2.24	0.64 - 0.02
		Field 1/4"	9.30 - 0.76	6.86 - 0.57	4.60 - 0.38	3.44 - 0.28	2.30 - 0.19	1.39 - 0.12	12.34 - 2.24	0.64 - 0.02
		Field 1/3"	13.95 - 1.14	10.29 - 0.85	6.89 - 0.57	5.17 - 0.44	3.45 - 0.29	2.09 - 0.17	12.34 - 2.24	0.64 - 0.02
		Field 1/2"	—	13.72 - 1.13	9.19 - 0.76	6.89 - 0.57	4.60 - 0.38	2.78 - 0.23	12.34 - 2.24	0.64 - 0.02
		Field 2/3"	—	(1) 12.20 - 1.55	12.64 - 1.05	9.48 - 0.78	6.33 - 0.52	3.83 - 0.32	12.34 - 2.24	0.64 - 0.02
2.0X 0.038 - 0.202 N.A. 1-50015	37	Mag.	0.58X - 6.98X	0.78X - 9.40X	1.16X - 14.00X	1.54X - 18.6X	2.32X - 28.00X	3.83X - 46.2X	9.00 - 1.66	0.35 - 0.01
		Field 1/4"	6.89 - 0.57	5.14 - 0.43	3.45 - 0.29	2.59 - 0.21	1.73 - 0.15	1.05 - 0.09	9.00 - 1.66	0.35 - 0.01
		Field 1/3"	10.34 - 0.85	7.72 - 0.64	5.18 - 0.43	3.89 - 0.32	2.59 - 0.22	1.57 - 0.13	9.00 - 1.66	0.35 - 0.01
		Field 1/2"	—	10.29 - 0.85	6.90 - 0.57	5.19 - 0.43	3.45 - 0.29	2.09 - 0.17	9.00 - 1.66	0.35 - 0.01
		Field 2/3"	—	(1) 9.10 - 1.17	9.49 - 0.78	7.14 - 0.59	4.75 - 0.40	2.88 - 0.24	9.00 - 1.66	0.35 - 0.01

(1) Vignetting occurs at zoom settings less than 0.9X.

(2) NA varies depending on zoom setting.

12X UltraZoom Field of View Matrix

1-50502, 1-50503 and 1-50504 (In mm)

Objective Lens (Mitutoyo) Long W.D.	W.D. (mm)	Camera Formats/ Parameters	1X Adapter Low - High	1.33X Adapter Low - High	2X Adapter Low - High	3.5X Adapter Low - High
5X 0.14 NA* 1-60226	34	Mag.	(1) 3.57X - 16.66X	(2) 3.26X - 22.16X	2.77X - 33.31X	4.80X - 58.30X
		Sensor 1/4"	1.12 - 0.24	1.22 - 0.18	1.44 - 0.12	0.83 - 0.07
		Sensor 1/3"	1.68 - 0.36	1.84 - 0.27	2.17 - 0.18	1.25 - 0.10
		Sensor 1/2"	2.24 - 0.48	2.45 - 0.36	2.89 - 0.24	1.66 - 0.14
		Sensor 2/3"	—	2.45 - 0.49	3.97 - 0.33	2.29 - 0.19
10X 0.28 NA* 1-60227	33	Mag.	(1) 7.14X - 33.31X	(2) 6.50X - 44.30X	5.54X - 66.63X	9.70X - 116.60X
		Sensor 1/4"	0.56 - 0.12	0.61 - 0.09	0.72 - 0.06	0.41 - 0.03
		Sensor 1/3"	0.84 - 0.18	0.92 - 0.13	1.08 - 0.09	0.62 - 0.05
		Sensor 1/2"	1.12 - 0.24	1.23 - 0.18	1.44 - 0.12	0.82 - 0.07
		Sensor 2/3"	—	1.23 - 0.25	1.99 - 0.17	1.13 - 0.09
20X 0.42 NA* 1-60228	20	Mag.	(1) 14.28X - 64.63X	(2) 13.10X - 85.96X	11.08X - 133.25X	19.40X - 233.20X
		Sensor 1/4"	0.28 - 0.06	0.30 - 0.04	0.36 - 0.03	0.21 - 0.02
		Sensor 1/3"	0.42 - 0.09	0.46 - 0.07	0.54 - 0.04	0.31 - 0.03
		Sensor 1/2"	0.56 - 0.12	0.61 - 0.09	0.72 - 0.06	0.41 - 0.03
		Sensor 2/3"	—	0.61 - 0.13	0.99 - 0.08	0.57 - 0.05
50X 0.55 NA* 1-60229	13	Mag.	(1) 35.69X - 166.57X	(2) 40.00X - 221.54X	27.50X - 333.13X	48.10X - 583.00X
		Sensor 1/4"	0.11 - 0.02	0.10 - 0.02	0.14 - 0.01	0.08 - .006
		Sensor 1/3"	0.17 - 0.04	0.15 - 0.05	0.22 - 0.02	0.12 - 0.01
		Sensor 1/2"	0.22 - 0.05	0.20 - 0.04	(2) 0.17 - 0.03	0.16 - 0.01
		Sensor 2/3"	—	0.20 - 0.05	0.40 - 0.03	0.23 - 0.02

Note: This system is not recommended for use with a 2/3" CCD.

(1) Zoom setting at 1.5X. (2) Zoom setting at 1.0X. *NA at full zoom. NA varies with zoom setting.

12X Zoom Field of View Matrix for Internal Coaxial Zoom

1-50487 (In mm)

Lens Attachment	W. D.	Camera Formats/ Parameters	.67X Adapter Low - High	1X Adapter Low - High	1.33X Adapter Low - High	2X Adapter Low - High	3.5X Adapter Low - High
None 0.019 - 0.101 NA	86	Mag.	0.39X - 4.70X	0.58X - 7.00X	0.77X - 9.31X	1.16X - 14.00X	2.03X - 24.50X
		Sensor 1/4"	10.29 - 0.85	6.90 - 0.57	5.19 - 0.43	3.45 - 0.29	1.97 - 0.16
		Sensor 1/3"	15.44 - 1.28	10.34 - 0.86	7.80 - 0.64	5.18 - 0.43	2.95 - 0.24
		Sensor 1/2"	20.58 - 1.70	13.79 - 1.14	10.39 - 0.86	6.90 - 0.57	3.94 - 0.32
		Sensor 2/3"	(1) 16.38 - 2.34	18.97 - 1.57	14.28 - 1.18	9.49 - 0.78	5.41 - 0.45
1.5X 0.028 - 0.151 NA 1-50014	50	Mag.	0.58X - 7.00X	0.87 - 10.50X	1.16X - 14.00X	1.74X - 21.00X	3.05X - 36.80X
		Sensor 1/4"	6.86 - 0.57	4.60 - 0.38	3.45 - 0.29	2.30 - 0.19	1.31 - 0.11
		Sensor 1/3"	10.29 - 0.85	6.89 - 0.57	5.17 - 0.43	3.45 - 0.29	1.96 - 0.16
		Sensor 1/2"	13.72 - 1.13	9.19 - 0.76	6.89 - 0.57	4.60 - 0.38	2.62 - 0.22
		Sensor 2/3"	(1) 10.92 - 1.55	12.64 - 1.05	9.48 - 0.79	6.33 - 0.52	3.61 - 0.30
2.0X 0.038 - 0.202 NA 1-50015	37	Mag.	0.78X - 9.40X	1.16X - 14.00X	1.54X - 18.6X	2.32X - 28.00X	4.06X - 49.00X
		Sensor 1/4"	5.14 - 0.43	3.45 - 0.29	2.59 - 0.22	1.73 - 0.15	0.98 - 0.08
		Sensor 1/3"	7.72 - 0.64	5.18 - 0.43	3.89 - 0.32	2.59 - 0.22	1.47 - 0.12
		Sensor 1/2"	10.29 - 0.85	6.90 - 0.57	5.19 - 0.43	3.45 - 0.29	1.97 - 0.16
		Sensor 2/3"	(1) 8.19 - 1.17	9.49 - 0.78	7.14 - 0.59	4.75 - 0.40	2.71 - 0.22

The internal coax will illuminate a circular area of about 14 mm in diameter. Any field of view larger than 14 mm will have darkened corners.

Low power lens attachments can be used but produce increasing vignetted. (1) Zoom Setting at 1.0=X. (2) NA varies depending on zoom setting

Matrices and Specifications

Precise Eye Field of View Matrix In mm at Nominal Working Distance

Lens Attachment	W.D. (mm)	Camera Format & Parameters	0.5X Adapter 1-62088	0.67X Adapter 1-61453	1.0X Adapter 1-61445	1.33X Adapter 1-61448	2.0X Adapter 1-61450
0.25X 0.018 NA DOF 1.59 mm 1-6044	310 (nominal)	Mag.	0.22X	0.30X	0.45X	0.60X	0.90X
		Sensor 1/4"	14.2(h) 10.6(v)	10.7(h) 8.0(v)	7.1(h) 5.3(v)	5.3(h) 4.0(v)	3.6(h) 2.7(v)
	282-351 (1) W.D. Range	Sensor 1/3"	21.4(h) 16.0(v)	15.9(h) 11.9(v)	10.7(h) 8.0(v)	8.0(h) 6.0(v)	5.3(h) 4.0(v)
		Sensor 1/2"	28.4(h) 21.4(v)	21.2(h) 15.9(v)	14.2(h) 10.7(v)	10.6(h) 8.0(v)	7.1(h) 5.3(v)
		Sensor 2/3"	39.2(h) 29.4(v)	—	19.6(h) 14.7(v)	14.7(h) 11.0(v)	—
0.5X 0.035 NA DOF 0.40 mm 1-60110	175 (nominal)	Mag.	0.45X	0.60X	0.90X	1.2X	1.8X
		Sensor 1/4"	7.2(h) 5.2(v)	5.3(h) 4.0(v)	3.6(h) 2.6(v)	2.7(h) 2.0(v)	1.8(h) 1.3(v)
	170-190 (1) W.D. Range	Sensor 1/3"	10.6(h) 8.0(v)	8.0(h) 6.0(v)	5.3(h) 4.0(v)	4.0(h) 3.0(v)	2.7(h) 2.0(v)
		Sensor 1/2"	14.2(h) 10.6(v)	10.6(h) 8.0(v)	7.1(h) 5.3(v)	5.3(h) 4.0(v)	3.6(h) 2.7(v)
		Sensor 2/3"	19.6(h) 14.6(v)	—	9.8(h) 7.3(v)	7.3(h) 5.5(v)	—
0.75X 0.054 NA DOF 0.18 mm 1-60111	113 (nominal)	Mag.	0.7X	0.90X	1.4X	1.8X	2.7X
		Sensor 1/4"	4.6(h) 3.6(v)	3.6(h) 2.7(v)	2.3(h) 1.8(v)	1.8(h) 1.3(v)	1.2(h) 0.9(v)
	110-120 (1) W.D. Range	Sensor 1/3"	7.2(h) 5.4(v)	5.3(h) 4.0(v)	3.6(h) 2.7(v)	2.7(h) 2.0(v)	1.8(h) 1.3(v)
		Sensor 1/2"	9.4(h) 7.2(v)	7.1(h) 5.3(v)	4.7(h) 3.6(v)	3.6(h) 2.7(v)	2.4(h) 1.8(v)
		Sensor 2/3"	13.0(h) 9.8(v)	—	6.5(h) 4.9(v)	4.9(h) 3.7(v)	—
None 0.070 NA DOF 0.10 mm	92 (nominal)	Mag.	0.9X	1.2X	1.8X	2.4X	3.6X
		Sensor 1/4"	3.6(h) 2.6(v)	2.7(h) 2.0(v)	1.8(h) 1.3(v)	1.3(h) 1.0(v)	0.9(h) 0.7(v)
	90-93 (1) W.D. Range	Sensor 1/3"	5.4(h) 4.0(v)	4.0(h) 3.0(v)	2.7(h) 2.0(v)	2.0(h) 1.5(v)	1.3(h) 1.0(v)
		Sensor 1/2"	7.2(h) 5.4(v)	5.3(h) 4.0(v)	3.6(h) 2.7(v)	2.7(h) 2.0(v)	1.8(h) 1.3(v)
		Sensor 2/3"	9.8(h) 7.4(v)	—	4.9(h) 3.7(v)	3.7(h) 2.8(v)	—
1.5X 0.104 NA DOF 0.04 mm 1-60112	51 (nominal)	Mag.	1.35X	1.8X	2.7X	3.6X	5.4X
		Sensor 1/4"	2.4(h) 1.8(v)	1.8(h) 1.3(v)	1.2(h) 0.9(v)	0.9(h) 0.7(v)	0.6(h) 0.4(v)
	49-51 (1) W.D. Range	Sensor 1/3"	3.6(h) 2.6(v)	2.7(h) 2.0(v)	1.8(h) 1.3(v)	1.3(h) 1.0(v)	0.9(h) 0.7(v)
		Sensor 1/2"	4.8(h) 3.6(v)	3.6(h) 2.7(v)	2.4(h) 1.8(v)	1.8(h) 1.3(v)	1.2(h) 0.9(v)
		Sensor 2/3"	6.6(h) 4.8(v)	—	3.3(h) 2.4(v)	2.4(h) 1.8(v)	—
2.0X 0.141 NA DOF 0.02 mm 1-60113	36 (nominal)	Mag.	1.8X	2.4X	3.6X	4.8X	7.2X
		Sensor 1/4"	1.8(h) 1.4(v)	1.3(h) 1.0(v)	0.9(h) 0.7(v)	0.7(h) 0.5(v)	0.5(h) 0.3(v)
	35-36 (1) W.D. Range	Sensor 1/3"	2.6(h) 2.0(v)	2.0(h) 1.5(v)	1.3(h) 1.0(v)	1.0(h) 0.8(v)	0.7(h) 0.5(v)
		Sensor 1/2"	3.6(h) 2.6(v)	2.7(h) 2.0(v)	1.8(h) 1.3(v)	1.3(h) 1.0(v)	0.9(h) 0.7(v)
		Sensor 2/3"	4.8(h) 3.6(v)	—	2.4(h) 1.8(v)	1.8(h) 1.4(v)	—

(1) Working distance range when using 3 mm fine focus. Field of view will change with shorter or longer working distances.

Ultra Precise Eye Magnification Matrix (In mm)

Infinity Corrected Objective (Mitutoyo)	W.D. (mm)	Camera Format & Parameters	0.5X Adapter 1-62088	0.67X Adapter 1-61453	1.0X Adapter 1-61445	1.33X Adapter 1-61448	2.0X Adapter 1-61450
5X 0.14 NA 1-60226	34	Mag.	2.27X	3.05X	4.55X	6.10X	9.10X
		Sensor 1/4"	1.4(h) 1.06(v)	1.05(h) 0.79(v)	0.70(h) 0.53(v)	0.52(h) 0.39(v)	0.35(h) 0.26(v)
		Sensor 1/3"	2.12(h) 1.58(v)	1.57(h) 1.18(v)	1.06(h) 0.79(v)	0.79(h) 0.59(v)	0.53(h) 0.40(v)
		Sensor 1/2"	2.82(h) 2.12(v)	2.10(h) 1.58(v)	1.41(h) 1.06(v)	1.05(h) 0.79(v)	0.70(h) 0.53(v)
		Sensor 2/3"	—	—	1.93(h) 1.46(v)	1.44(h) 1.08(v)	—
10X 0.28 NA 1-60227	33	Mag.	4.55X	6.1X	9.10X	12.2X	18.2X
		Sensor 1/4"	0.70(h) 0.52(v)	0.52(h) 0.39(v)	0.35(h) 0.26(v)	0.26(h) 0.20(v)	0.18(h) 0.13(v)
		Sensor 1/3"	1.06(h) 0.80(v)	0.79(h) 0.59(v)	0.53(h) 0.40(v)	0.39(h) 0.30(v)	0.26(h) 0.20(v)
		Sensor 1/2"	1.40(h) 1.06(v)	1.05(h) 0.79(v)	0.70(h) 0.53(v)	0.52(h) 0.39(v)	0.35(h) 0.26(v)
		Sensor 2/3"	—	—	0.97(h) 0.73(v)	0.72(h) 0.54(v)	—
20X 0.42 NA 1-60228	20	Mag.	9.1X	12.2X	18.2X	24.4X	36.4X
		Sensor 1/4"	0.36(h) 0.26(v)	0.26(h) 0.20(v)	0.18(h) 0.13(v)	0.13(h) 0.10(v)	0.09(h) 0.07(v)
		Sensor 1/3"	0.52(h) 0.40(v)	0.39(h) 0.30(v)	0.26(h) 0.20(v)	0.20(h) 0.15(v)	0.13(h) 0.10(v)
		Sensor 1/2"	0.70(h) 0.52(v)	0.52(h) 0.39(v)	0.35(h) 0.26(v)	0.26(h) 0.20(v)	0.18(h) 0.14(v)
		Sensor 2/3"	—	—	0.48(h) 0.36(v)	0.36(h) 0.27(v)	—
50X 0.55 NA 1-60229	13	Mag.	22.75X	30.5X	45.5X	61.0X	91.0X
		Sensor 1/4"	0.14(h) 0.10(v)	0.10(h) 0.08(v)	0.07(h) 0.05(v)	0.05(h) 0.04(v)	0.04(h) 0.03(v)
		Sensor 1/3"	0.22(h) 0.16(v)	0.16(h) 0.12(v)	0.11(h) 0.08(v)	0.08(h) 0.06(v)	0.06(h) 0.04(v)
		Sensor 1/2"	0.28(h) 0.22(v)	0.21(h) 0.16(v)	0.14(h) 0.11(v)	0.11(h) 0.08(v)	0.07(h) 0.05(v)
		Sensor 2/3"	—	—	0.19(h) 0.15(v)	0.14(h) 0.11(v)	—

NOTE: The O-I remains constant for each body tube (main assembly) regardless of which infinity corrected objective and adapter are selected:
1-61517 O-I = 219 mm, 1-61521 O-I = 243 mm, 1-61522 O-I = 263 mm

Matrices and Specifications

Precise Eye Field of View Matrix for Internal Coaxial In mm at Nominal Working Distance

Lens Attachment	W.D. (mm)	Camera Format & Parameters	0.5X Adapter 1-62088	0.67X Adapter 1-61453	1.0X Adapter 1-61445	1.33X Adapter 1-61448	2.0X Adapter 1-61450
0.5X 0.035 NA DOF 0.40 mm 1-60110	175 (nominal)	Mag.	0.45X	0.60X	0.90X	1.2X	1.8X
		Sensor 1/4"	7.2(h) 5.2(v)	5.3(h) 4.0(v)	3.6(h) 2.6(v)	2.7(h) 2.0(v)	1.8(h) 1.3(v)
	170-190 (1) W.D. Range	Sensor 1/3"	—	8.0(h) 6.0(v)	5.3(h) 4.0(v)	4.0(h) 3.0(v)	2.7(h) 2.0(v)
		Sensor 1/2"	—	—	7.1(h) 5.3(v)	5.3(h) 4.0(v)	3.6(h) 2.7(v)
		Sensor 2/3"	—	—	—	7.3(h) 5.5(v)	—
0.75X 0.054 NA DOF 0.17 mm 1-60111	113 (nominal)	Mag.	0.7X	0.90X	1.4X	1.8X	2.7X
		Sensor 1/4"	4.6(h) 3.6(v)	3.6(h) 2.7(v)	2.3(h) 1.8(v)	1.8(h) 1.3(v)	1.2(h) 0.9(v)
	110-120 (1) W.D. Range	Sensor 1/3"	7.2(h) 5.4(v)	5.3(h) 4.0(v)	3.6(h) 2.7(v)	2.7(h) 2.0(v)	1.8(h) 1.3(v)
		Sensor 1/2"	—	7.1(h) 5.3(v)	4.7(h) 3.6(v)	3.6(h) 2.7(v)	2.4(h) 1.8(v)
		Sensor 2/3"	—	—	6.5(h) 4.9(v)	4.9(h) 3.7(v)	—
None 0.070 NA DOF 0.10 mm	92 (nominal)	Mag.	0.9X	1.2X	1.8X	2.4X	3.6X
		Sensor 1/4"	3.6(h) 2.6(v)	2.7(h) 2.0(v)	1.8(h) 1.3(v)	1.3(h) 1.0(v)	0.9(h) 0.7(v)
	90-93 (1) W.D. Range	Sensor 1/3"	5.4(h) 4.0(v)	4.0(h) 3.0(v)	2.7(h) 2.0(v)	2.0(h) 1.5(v)	1.3(h) 1.0(v)
		Sensor 1/2"	7.2(h) 5.4(v)	5.3(h) 4.0(v)	3.6(h) 2.7(v)	2.7(h) 2.0(v)	1.8(h) 1.3(v)
		Sensor 2/3"	—	—	4.9(h) 3.7(v)	3.7(h) 2.8(v)	—
1.5X 0.104 NA DOF 0.046 mm 1-60112	51 (nominal)	Mag.	1.35X	1.8X	2.7X	3.6X	5.4X
		Sensor 1/4"	2.4(h) 1.8(v)	1.8(h) 1.3(v)	1.2(h) 0.9(v)	0.9(h) 0.7(v)	0.6(h) 0.4(v)
	49-51 (1) W.D. Range	Sensor 1/3"	3.6(h) 2.6(v)	2.7(h) 2.0(v)	1.8(h) 1.3(v)	1.3(h) 1.0(v)	0.9(h) 0.7(v)
		Sensor 1/2"	4.8(h) 3.6(v)	3.6(h) 2.7(v)	2.4(h) 1.8(v)	1.8(h) 1.3(v)	1.2(h) 0.9(v)
		Sensor 2/3"	6.6(h) 4.8(v)	—	3.3(h) 2.4(v)	2.4(h) 1.8(v)	—
2.0X 0.141 NA DOF 0.025 mm 1-60113	36 (nominal)	Mag.	1.8X	2.4X	3.6X	4.8X	7.2X
		Sensor 1/4"	1.8(h) 1.4(v)	1.3(h) 1.0(v)	0.9(h) 0.7(v)	0.7(h) 0.5(v)	0.5(h) 0.3(v)
	35-36 (1) W.D. Range	Sensor 1/3"	2.6(h) 2.0(v)	2.0(h) 1.5(v)	1.3(h) 1.0(v)	1.0(h) 0.8(v)	0.7(h) 0.5(v)
		Sensor 1/2"	3.6(h) 2.6(v)	2.7(h) 2.0(v)	1.8(h) 1.3(v)	1.3(h) 1.0(v)	0.9(h) 0.7(v)
		Sensor 2/3"	4.8(h) 3.6(v)	—	2.4(h) 1.8(v)	1.8(h) 1.4(v)	—

Notes:

The internal coax will illuminate a circular area of about 11 mm in diameter. Any field of view larger than 11 mm will have darkened corners.

(1) Working distance range when using 3 mm fine focus. Field of view will change with shorter or longer working distance.

Reference Information

Matrices and Specifications
Resources

Magnification Overview of Navitar Lenses

Magnification

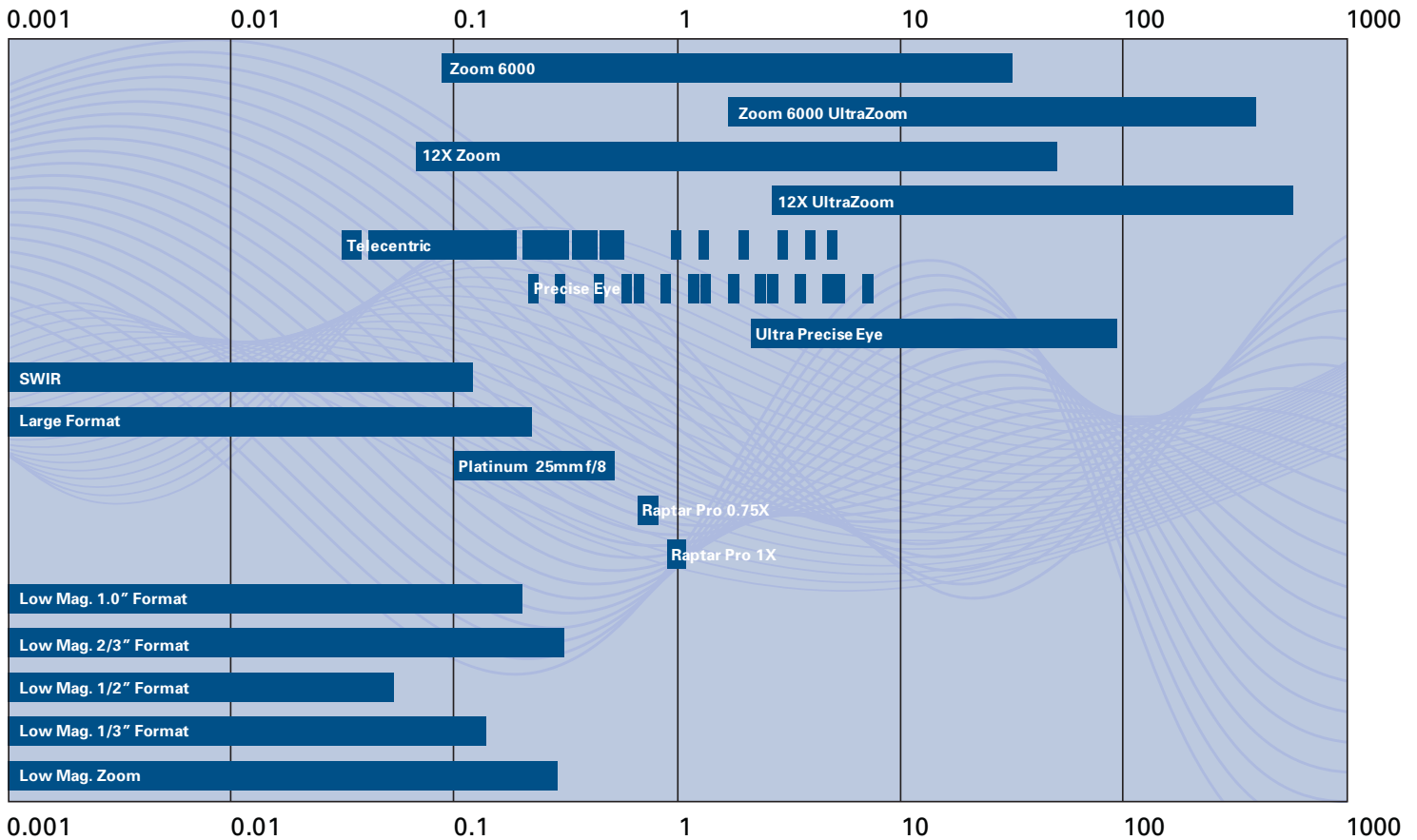

General Lens Formulas

Focal Length

$$FL = CCD \times WD / FOV$$

Magnification

$$m = \text{Image Size} / \text{Object Size}$$

Object to Image Distance

$$OI = [FL \times (1+m)^2] / m$$

$$OI = m(FL) + (FL + VOA + BF) + FL / m$$

VOA = Vertex to Vertex Lens Length

Object to Lens Distance

$$OL = FL + FL / m$$

Lens to Image Distance

$$LI = FL + FL / m$$

(Approximate distance to the nodal points:
FL + FL(m) to the front vertex.)

$$F/\# = 1 / (2NA)$$

$$F/\# = FL / \text{Entrance Pupil Diameter}$$

$$NA = 1/2 F/\#$$

$$NA = \sin \theta / 2$$

Effective F/#

$$\text{Eff. } F/\# = F/\# (m+1)$$

Clear Aperture (Minimum)

$$\text{Aperture} = FL / (F/\#)$$

Depth of Focus

$$\text{DoF} = 0.00002 / NA^2 \text{ (in inches)}$$

$$\text{DoF} = 0.0005 / NA^2 \text{ (in mm)}$$

Conversion Factors

1 inch = 25.4 millimeters

1 meter = 39.37 inches

1 degree = $\pi / 180$ radians

1 degree = 0.0174533 radians

1 micron (μ) = 0.001 millimeter

1 micron (μ) = 1,000 nanometers (nm)

1 micron (μ) = 10,000 angstroms (\AA)

Image Sensor Size (units in mm)

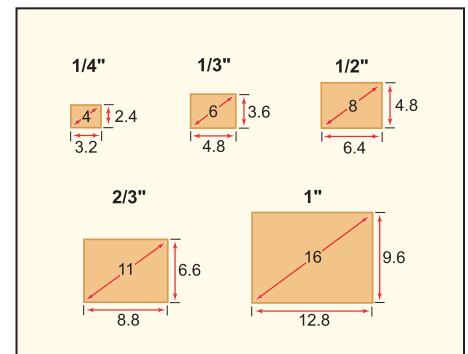

Online Resources

The Optical Wizard

With our patented online tool, the Optical Wizard, you can easily configure complete imaging solutions. The Wizard offers customized suggestions to suit your needs and budget.

www.opticalwizard.com



Digital Resources Library

Navitar offers a number of digital resources for your reference, including brochures and interactive catalogs.

www.navitar.com/support/digital_resources.html

How to Order



Call 585-359-4000 or call us toll-free at 800-828-6778.



Visit www.navitar.com for secure and simple online ordering, or email us at info@navitar.com.



Submit your purchase order by fax at 585-359-4999.

Optical Solutions for Many Applications & Industries

Biotechnology and Medical

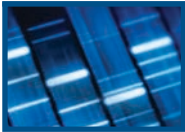

- Flow Cytometry
- Cellular Analysis
- Fluorescence Imaging
- Laser Eye Surgery
- DNA Sequencing
- *In vitro* Fertilization
- Gel Documentation
- Two-Photon Microscopy

Defense and Security

- SWIR Imaging
- Military Robotics
- Long-Range Surveillance
- 360° Situational Awareness
- Airborne Imaging
- Laser Weapons
- Laser Defense
- Training and Simulation Projection



Industrial Imaging



- Semiconductor Metrology
- Electronic Imaging
- Telecommunications
- Biometrics
- Photonics Research and Development
- Non-Contact Measurement
- Biotechnology

Projection Optics

- Religious/Praise & Worship
- Home Theater & 2D/3D/4D Cinema
- Planetarium
- Amusement/Theme Parks
- Simulation
- Education
- Spherical Digital Display Systems

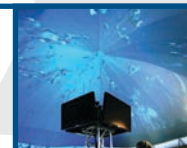

**Designing, Developing and Manufacturing
Optical Solutions for Over 60 Years.**



200 Commerce Drive | Rochester, NY 14623

Phone: 585-359-4000 | Toll Free: 800-828-6778

Email: info@navitar.com | Web: www.navitar.com